



AANVRAAG

BESTELLING

ELEMENT OP MAAT

Graag invullen en sturen naar info@gev-online.nl

Bedrijf/Adres
Bedrijfstempel

Naam aanvrager

Datum

Klantnummer

Uw orderreferentie

Afleveradres (indien anders dan factuuradres)

Maat

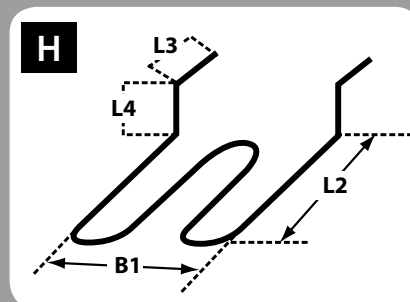
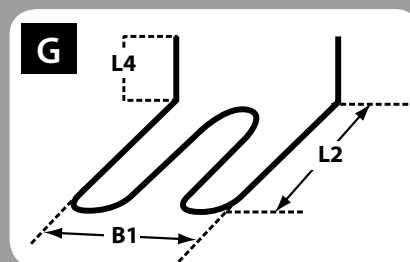
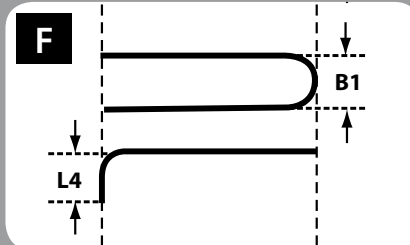
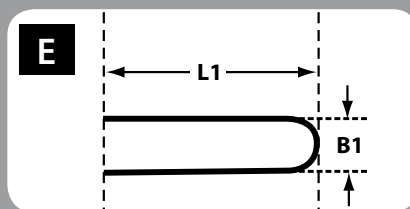
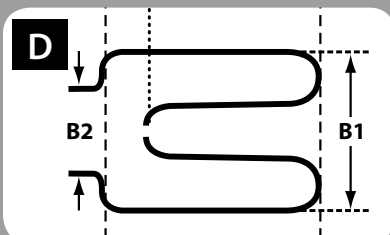
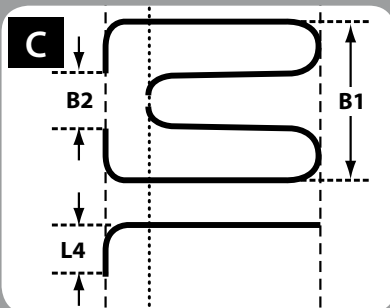
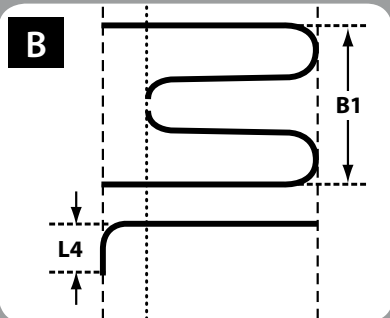
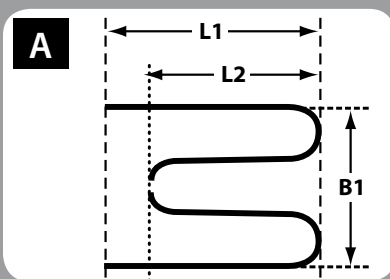

Aantal:

..... stuk

Versie:

A B C D
 E F G H

Maat :

(Buisseinde – zonder keramische deel)

L1: mm

L2: mm

L3: mm

L4: mm

B1: mm

B2: mm

ELEMENT OP MAAT

Graag invullen en sturen naar info@gev-online.nl

Aansluittype

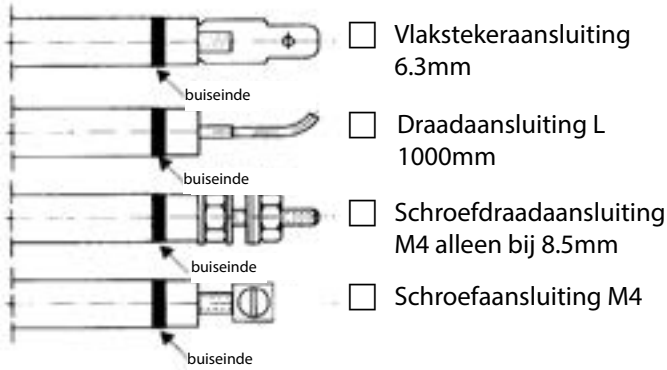

Technische gegevens

GEMIDDELD:

In water:

Materiaal AISI 316TI 6.5mm 8.5mm

In olie/loog/zoutwater:

Materiaal INCOLOY 825 6.5mm 8.5mm

Droog:

Materiaal AISI 309F 6.5mm 8.5mm

Materiaal koper
verchromd

Spanning: 230V 400V

Vermogen: W

Aantal windingen:
(Bijv. E = 1 winding, A = 2 windingen)

Inschroefvariant

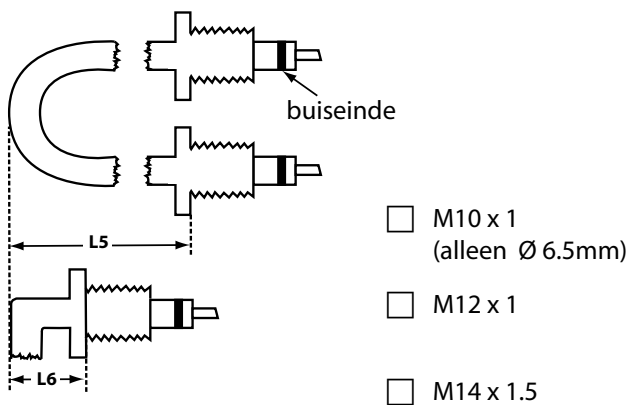

L5:mm

L6:mm