



Reparatie-onderdelen voor **Koelapparatuur**



Reparatie-onderdelen passend voor

ISA

2018

Het complete assortiment vindt u altijd up-to-date in onze webshop

verwarmingselementen

verwarmingspatronen

			
1			
bestelnr.	419216	fabrikantnr.	41850002800 418500028000
omschrijving	verwarmingspatroon 250W 230V ø 11mm L 116mm kabel- lengte 2000mm aansluiting vlakstekker 6,3mm koel		

			
1			
bestelnr.	419218	fabrikantnr.	418500030100
omschrijving	verwarmingspatroon 400W 230V ø 12mm L 240mm draad 3/8" kabellengte 1000mm aansluiting vlakstekkerhuls 6,3mm koel		

			
1			
bestelnr.	419217	fabrikantnr.	418500020000
omschrijving	verwarmingspatroon 700W 230V ø 11mm L 355mm kabel- lengte 1500mm aansluiting vlakstekkerhuls 6,3mm		

thermostaten

clixonthermostaten

clixonthermostaten

			
1			
bestelnr.	390930	fabrikantnr.	50501404000
omschrijving	clixonthermostaat uitschakeltemp. 10°C 1-polig inscha- keltemp. -1°C kabellengte 2500mm		

timers

programmatimers

			
1			
bestelnr.	360590	fabrikantnr.	50502800200
omschrijving	timer EI30/15,5 motoren kamers looptijd 25s 230V 50/60Hz as ømm as Lmm RITARDAT.RT-123/00		

relais

vermogensrelais

met soldeerbevestiging

			
1			
bestelnr.	380687	fabrikantnr.	30506030 50500601400
omschrijving	vermogensrelais FINDER 230VAC 30A 2NO aansluiting F6,3 overslagbevestiging fabrikant nr. 66.82.8.230.0300		

elektronische regelaars

CAREL

koelcelregelaars

inbouwversies

			
1			
bestelnr.	378491	fabrikantnr.	418200090000
omschrijving	elektronische regelaar CAREL PZIAC0H010K inbouwmaat 71x29mm inbouwdiepte 59mm 230V spanning AC NTC relaisuitgang 3 NO-12A CO-8A NO-8A NTC NTC bescherming IP65 ISA-TASSELLI-40 tot +99°C beeldscherm 3½ digits		

DIXELL

koelcelregelaars

inbouwversies

			
1			
bestelnr.	378492	fabrikantnr.	41825755200
omschrijving	elektronische regelaar DIXELL XR72CX inbouwmaat 71x29mm inbouwdiepte 59mm 12V spanning AC/DC NTC/ PTC relaisuitgang 4 NO-16A NO-8A NO-8A NO-5A DI NTC/ PTC NTC/PTC ja bescherming IP65 afhankelijk van voeler°C beeldscherm 3½ digits		



ELIWELL

koelcelregelaars

inbouwversies



1

bestelnr.	381403	fabrikantnr.	418200073000 418200073100 418200073200
omschrijving	elektronische regelaar ELIWELL type EWPlus 974 inbouwmaat 71x29mm 230V spanning AC NTC relaisuitgang 4 NO-12A(8) NO-8A(4) NC-6A(3) NO-5A(2) NTC NTC DI ontdooifunctie ja -50 tot +110°C beeldscherm 3½ digits		
Toebehoren voor	381403		
	bestelnr.	379052	fabrikantnr. —
	temperatuurvoeler PTC 1kOhm kabel silicone voeler -50 tot +150°C kabel -50 tot +180°C voeler ø6x40mm kabellengte 1.5m zonder schroefaansluiting 2-aderig		
	bestelnr.	379053	fabrikantnr. —
	temperatuurvoeler PTC 1kOhm kabel PVC voeler -50 tot +150°C kabel -10 tot +100°C voeler ø6x30mm kabellengte 3m zonder schroefaansluiting 2-aderig		
	bestelnr.	379064	fabrikantnr. —
	temperatuurvoeler PTC 1kOhm kabel silicone voeler -50 tot +150°C kabel -50 tot +180°C voeler ø6x40mm kabellengte 3m zonder schroefaansluiting 2-aderig		
	bestelnr.	379142	fabrikantnr. —
	temperatuurvoeler PTC 1kOhm kabel PVC voeler -50 tot +150°C kabel -10 tot +100°C voeler ø6x30mm kabellengte 1.5m zonder schroefaansluiting 2-aderig		
	bestelnr.	379160	fabrikantnr. —
	temperatuurvoeler NTC 10kOhm kabel thermoplast voeler -40 tot +110°C kabel -40 tot +110°C voeler ø6x14mm kabellengte 1.5m zonder schroefaansluiting 2-aderig		
	bestelnr.	379161	fabrikantnr. —
	temperatuurvoeler NTC 10kOhm kabel thermoplast voeler -40 tot +110°C kabel -40 tot +110°C voeler ø6x14mm kabellengte 3m zonder schroefaansluiting 2-aderig		
	bestelnr.	379162	fabrikantnr. —
	temperatuurvoeler NTC 10kOhm kabel thermoplast voeler -40 tot +110°C kabel -40 tot +110°C voeler ø6x14mm kabellengte 6m 2-aderig		
	bestelnr.	379169	fabrikantnr. —
	temperatuurvoeler NTC 10kOhm kabel thermoplast voeler -40 tot +110°C kabel -40 tot +110°C voeler ø6x14mm kabellengte 2m zonder schroefaansluiting 2-aderig		
	bestelnr.	379199	fabrikantnr. —
	temperatuurvoeler PTC 1kOhm kabel PVC voeler -50 tot +150°C kabel -10 tot +100°C voeler ø6x30mm kabellengte 5m zonder schroefaansluiting 2-aderig		
	bestelnr.	379343	fabrikantnr. —
	temperatuurvoeler NTC 10kOhm kabel silicone voeler -40 tot +110°C kabel -50 tot +180°C voeler ø6x40mm kabellengte 3m 2-aderig		
	bestelnr.	379458	fabrikantnr. —
	temperatuurvoeler NTC 10kOhm kabel silicone voeler -40 tot +110°C kabel -50 tot +180°C voeler ø6x40mm kabellengte 1.5m zonder schroefaansluiting 2-aderig		

Toebehoren voor	381403		
	bestelnr.	379630	fabrikantnr. —
	temperatuurvoeler NTC 10kOhm kabel thermoplast voeler -40 tot +110°C kabel -40 tot +110°C voeler ø6x14mm kabellengte 2.5m zonder schroefaansluiting 2-aderig weerstand 10kOhm		
	bestelnr.	379804	fabrikantnr. —
	bescherming voor elektronische regelaar 71x29 L 93mm B 65mm plexiglass		
	bestelnr.	381407	fabrikantnr. —
	temperatuurvoeler Pt1000 voeler -50 tot +110°C kabel silicone voeler ø5x20mm kabellengte 3m bescherming IP68		
	bestelnr.	550802	fabrikantnr. —
	printplaat aansluitingen 4-polig roostermaat 5mm		
	bestelnr.	550805	fabrikantnr. —
	printplaat aansluitingen 7-polig roostermaat 5mm		

voelers

universele voelers

temperatuurvoelers

	bestelnr.	381222	fabrikantnr.	418303463100
omschrijving	temperatuurvoeler PTC 1kOhm kabel silicone voeler -50 tot +150°C kabel -50 tot +180°C voeler ø6x30mm kabellengte 3m kabelkleur grijs 2-aderig			

	bestelnr.	381221	fabrikantnr.	418316740000
omschrijving	temperatuurvoeler PTC 1kOhm kabel silicone voeler -50 tot +150°C kabel -50 tot +180°C voeler ø6x40mm kabellengte 1.5m 2-aderig			

elektronica

printplaten

	bestelnr.	360636	fabrikantnr.	418221547100
omschrijving	printplaat ON-OFF L 120mm B 40mm passend voor ISA			



bedieningsfoliën

bedieningseenheden



1

bestelnr.	403576	fabrikantnr.	418294090000
omschrijving	bedieningsprint knoppen 12 grijs passend voor ISA		

ventilatoren

koelventilatoren

koelventilatoren (compleet)

ELCO



1

bestelnr.	602030	fabrikantnr.	41812963100
------------------	--------	---------------------	-------------

omschrijving	ventilator ventilatorblad ø 100mm 230V 50-60Hz 10W 2500U/min aansluiting Faston zonder ventilatorblad		
---------------------	---	--	--

Reparatie-onderdelen voor 602030



bestelnr.	601563	fabrikantnr.	—
omschrijving	ventilatorblad zuigend ø 96mm asafname ø 4mm vleugelhoek 26° B 18mm aluminium passend voor 601039		



bestelnr.	601564	fabrikantnr.	—
omschrijving	ventilatorblad drukkend ø 96mm asafname ø 4mm vleugelhoek 26° B 18mm aluminium passend voor 601056		

Toebehoren voor 602030



bestelnr.	602062	fabrikantnr.	—
omschrijving	stekerkabel ELCO kabellengte 1500mm 0.75mm ² bescherming IP44 voor Plug-In		

diversen



1

bestelnr.	601857	fabrikantnr.	30413698 4152.0518 52A-20001/16 R400002486000 R400064297000
------------------	--------	---------------------	---

omschrijving	ventilator 230V 50/60Hz 15W ø 96mm type 52A-20001/16 2500U/min drukkend ventilatorblad ø 96mm kabellengte 3000mm aansluiting met kabel inbouw ø 110mm inbouwdiepte 98mm		
---------------------	---	--	--

apparaatspecifieke bouwdeelen

voor koelwerkbanken

deksellagers



1

bestelnr.	696667	fabrikantnr.	442700041005
------------------	--------	---------------------	--------------

omschrijving	houder aluminium voor scharnier voor deur inbouwpositie links		
---------------------	---	--	--



1

bestelnr.	696668	fabrikantnr.	442700042005
------------------	--------	---------------------	--------------

omschrijving	houder aluminium voor scharnier voor deur inbouwpositie links		
---------------------	---	--	--



1

bestelnr.	696665	fabrikantnr.	442700044005
------------------	--------	---------------------	--------------

omschrijving	houder aluminium voor scharnier voor deur inbouwpositie rechts		
---------------------	--	--	--



1

bestelnr.	696666	fabrikantnr.	442700043005
omschrijving	houder aluminium voor scharnier voor deur inbouwpositie rechts		

sluitingen

snapsluitingen

fabrikantspecifiek

ISA



1

bestelnr.	692857	fabrikantnr.	50230200300
omschrijving	snapslot L 82mm B 38mm H 35mm bevestigingsafstand 27mm veerdikte 1.6mm voor ijsvitirine		

scharnieren

zijkscharnieren

diversen



1

bestelnr.	692599	fabrikantnr.	50230102300
omschrijving	zijkscharnier L 102mm B 19mm bevestigingsafstand 62mm aanslag links/rechts zonder verhoging kunststof grijs koelapparaat draaipunt 24mm		

veerscharnieren

fabrikantspecifiek

ISA



1

bestelnr.	692600	fabrikantnr.	24563
omschrijving	veerscharnier rechts/links L 73mm B 24mm H 100mm koelapparaat bevestigingsafstand 26mm		

deurlagers



1

bestelnr.	692601	fabrikantnr.	442700045005
omschrijving	scharnier L 40mm B 25mm inbouwpositie onder links materiaaldikte 7mm		



1

bestelnr.	692598	fabrikantnr.	442700040005
omschrijving	scharnier L 40mm B 25mm inbouwpositie onder rechts materiaaldikte 7mm vpe 1stuk		

rubbers

koeldeurrubbers

insteekprofielen

Profiel 9048

We kunnen voor dit profiel rubbers op maat produceren

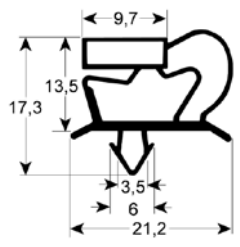

1

bestelnr.	901619	fabrikantnr.	42403329900
omschrijving	koeldeurrubber profiel 9048 B 675mm L 1535mm steekmaat		



Profiel 9703

We kunnen voor dit profiel rubbers op maat produceren

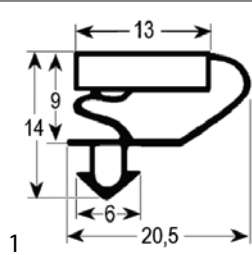

bestelnr.	970884	fabrikantnr.	29013
omschrijving	koeldeurrubber profiel 9703 B 172mm L 426mm steekmaat		

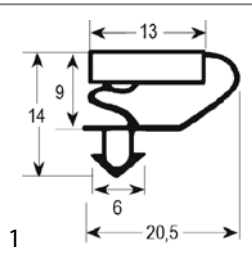

bestelnr.	970819	fabrikantnr.	29011
omschrijving	koeldeurrubber profiel 9703 B 281mm L 424mm steekmaat		

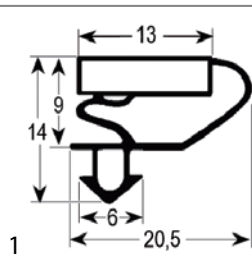

bestelnr.	970885	fabrikantnr.	29014
omschrijving	koeldeurrubber profiel 9703 B 390mm L 424mm steekmaat		

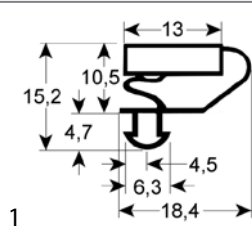

bestelnr.	900933	fabrikantnr.	29012 30546
omschrijving	koeldeurrubber profiel 9703 B 436mm L 616mm steekmaat L1 606mm B1 426mm buitenmaat		

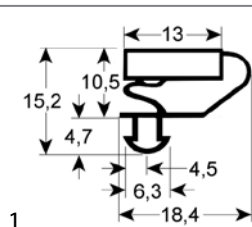

bestelnr.	901058	fabrikantnr.	424019211000
omschrijving	koeldeurrubber profiel 9703 B 632mm L 1320mm steekmaat L1 1314mm B1 626mm buitenmaat		

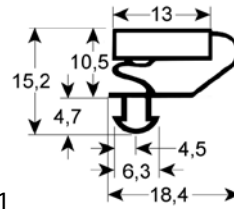

bestelnr.	901668	fabrikantnr.	424000017000
omschrijving	koeldeurrubber profiel 9703 B 755mm L 910mm steekmaat		

Profiel 9704

We kunnen voor dit profiel rubbers op maat produceren

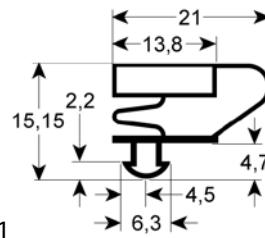

bestelnr.	901978	fabrikantnr.	29015
omschrijving	koeldeurrubber profiel 9704 B 398mm L 278mm steekmaat vergelijkingsnr. 29015		

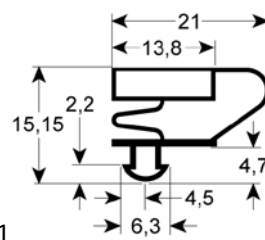

bestelnr.	901680	fabrikantnr.	29017
omschrijving	koeldeurrubber profiel 9704 B 525mm L 615mm steekmaat L1 606mm B1 516mm buitenmaat		

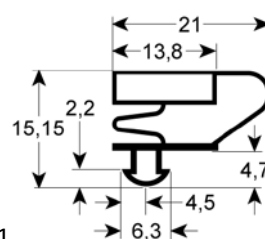

bestelnr.	901976	fabrikantnr.	29009
omschrijving	koeldeurrubber profiel 9704 B 689mm L 1565mm steekmaat L1 1555mm B1 675mm buitenmaat passend voor ISA		



Profiel 9012

We kunnen voor dit profiel rubbers op maat produceren

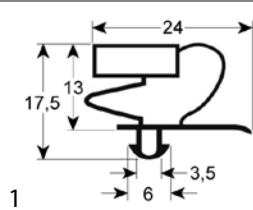

bestelnr.	901620	fabrikantnr.	28047721
omschrijving	koeldeurrubber profiel 9012 B 625mm L 1595mm steekmaat		

koelcomponenten

ventielen

terugslagventielen



bestelnr.	370791	fabrikantnr.	50600401200
omschrijving	terugslagventiel 4-wegs RANCO type V2-408060200 ingang 1/2" (12,84mm) uitgang 3/8" (9,67mm) vermogensbereik (R407C) 2,81-6,33 kW vermogensbereik (R410A) 3,17-7,74 kW vermogensbereik (R134A) 2,46-4,92 kW		
Toebehoren voor	370791	bestelnr.	371306
	fabrikantnr.	—	
omschrijving	magneetspoel ELIWELL 208/240VAC 50/60Hz 5/4W kabel-lengte 2000mm		

reparatieonderdelen en toebehoren



bestelnr.	371302 ¹	fabrikantnr.	50504200500
omschrijving	magneetspoel ELIWELL 230 50/60Hz 5/4W kabellengte 1200mm groen		

¹incl. kabel 1200mm

verdampers

voor koelkasten

fabrikantspecifiek



bestelnr.	750590	fabrikantnr.	420081399000
omschrijving	verdampers L 345mm B 120mm D 280mm totale lengte 390mm passend voor ISA-TASSELLI		



bestelnr.	750544	fabrikantnr.	420181938000
omschrijving	verdampers L 390mm B 355mm H 100mm passend voor ISA		

verdamp- en condenswaterschalen

verdampingsbakken onverwarmd

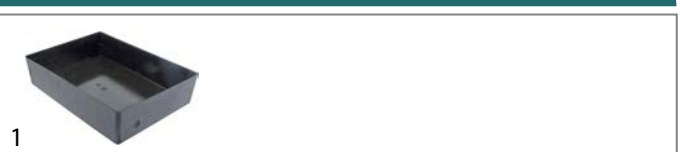

bestelnr.	750542	fabrikantnr.	442254412000
omschrijving	verdampingsbak L 400mm B 290mm H 88mm kunststof		



bestelnr.	750541	fabrikantnr.	442241872100
omschrijving	verdampingsbak L 475mm B 265mm H 90mm kunststof		

C

clixonthermostaten 2,2

E

elektronische regelaars 2

G

GEV 2

I

insteekprofielen 5

K

koelcomponenten 7

koeldeurrubbers 5

koelventilatoren 4

koelventilatoren (compleet) 4

P

programmatimers 2

R

relais 2

S

snapsluitingen 5

T

temperatuurvoelers 3

terugslagventielen 7

thermostaten 2

timers 2

U

universele voelers 3

V

veerscharnieren 5

ventilatoren 4

verdampers 7

verwarmingselementen 2

verwarmingpatronen 2

voelers 3

Z

zijkantscharnieren 5