



GAS



ELEKTRA



WATER



MECHANIEK



GEREEDSCHAP

Reparatie-onderdelen passend voor

DESCO

Het complete assortiment vindt u altijd up-to-date in onze webshop



Fabrikant-catalogussen

Per fabrikant de belangrijkste vervangingsonderdelen en toebehoren overzichtelijk bij elkaar

- ✓ **Compleet assortiment en altijd de actuele apparatuurgegevens in de GEV-Webshop**
- ✓ **Alfabetische Index achter in de catalogus**

GEV-Webshop

www.gev-online.nl



- 🔍 **Artikel als favoriet opslaan**
- 🔍 **Inloggen met E-mailadres en bekende paswoord**
- 🔍 **Bulk bestellen - meerdere artikelen direct in de winkelwagen laden**
- 🔍 **Direct op artikel zoeken zonder je hoeven aan te melden**

verwarmingselementen

elementen voor salamanders en toasters

1	
bestelnr.	415450 fabrikantnr. R_6002058-GI
omschrijving	verwarmingselement 650W 230V L 265mm B 55mm draad M15x1 bevestigingsafstand 45mm aansluitingslengte 38mm pijp ø 10mm VC 1 droog verwarmingselement 2-gatsbevestiging H 10mm

stralingselementen

1-kring

1	
bestelnr.	490025 fabrikantnr. 860060
omschrijving	stralingselement ø 200mm 1700W 230V VC 1 energieregeling met temperatuurmelder met verwarmingsspoel aansluitingen 2+2 aansluitingstype vlakstekker 6,3mm EGO

kookplaten

vierkant + rechthoekig

met afdekrand

1	
bestelnr.	490056 ¹ fabrikantnr. 60209
omschrijving	kookplaat maat 300x300mm 3000W 230V met oversteekrand aansluiting 4 schroefklemmen protector ja vierkant

¹incl. protector

rond

met afdekrand

voor huishoudens + grootkeuken

1	
bestelnr.	490020 fabrikantnr. 60208
omschrijving	kookplaat ø 220mm 2600W 230V aansluiting 4 schroefklemmen met 8mm oversteekrand
Toehoren voor	490020
	bestelnr. 550796 fabrikantnr. —
	bevestigingsplaat voor kookplaat ø220mm

thermostaten

regel- en maximaalthermostaten

EGO

regelthermostaten

serie 55.10/19_

1	
bestelnr.	390040 fabrikantnr. 60780
omschrijving	thermostaat t.max. 90°C instelbereik 30-90°C 1-polig 1CO 16A voeler ø 6mm voeler L 130mm capillaire 2040mm capillaire pijp geïsoleerd 1940mm stopbus as ø 6x4,6mm as L 23mm aspositie boven rotatiehoek 270° voelermateriaal RVS

maximaal thermostaten

serie 55.32_

1	
bestelnr.	375394 fabrikantnr. 60774
omschrijving	maximaalthermostaat uitschakeltemp. 135°C 3-polig 1CO/2NC 20A voeler ø 6mm voeler L 73mm capillaire 1490mm capillaire pijp geïsoleerd 1350mm stopbus M9x1 voeler RVS



schakelaars en tasters

drukschakelaar/-knoppen

19x13mm



1

bestelnr.	301054	fabrikantnr.	61286
omschrijving	drukschakelaar tastend inbouwmaat 19x13mm rood 1NO 250V 16A aansluiting vlaksteker 6,3mm omgevingstemperatuur max. 105/55°C bescherming IP65 met afdekkap		

nokkenschakelaars

7-standen



1

bestelnr.	300025	fabrikantnr.	60452
omschrijving	nokkenschakelaar 7 schakelstanden 1NO/2CO schakelvolgorde 0-1-2-3-4-5-6 16A as ø 6x4,6mm as L 23mm aansluiting schroefaansluiting 7-standen keramiek		
Toebehoren voor	300025		
	bestelnr.	112172	fabrikantnr. —
	knop universeel ø 70mm zwart zonder adapter/symbool		
	bestelnr.	112213	fabrikantnr. —
	knopsymbool zilver schakelaar 7-standen t.max.°C OD ø 63mm ID ø 45.5mm		
	bestelnr.	112311	fabrikantnr. —
	knop adapter as ø 6x4,6mm L 0mm met veer		

4-schakelstanden



1

bestelnr.	300210	fabrikantnr.	60773 EL0127
omschrijving	nokkenschakelaar 4 schakelstanden 4NO schakelvolgorde 0-1-2-3 16A as ø 6x4,6mm as L 23mm aansluiting schroefaansluiting keramiek		
Toebehoren voor	300210		
	bestelnr.	551456	fabrikantnr. —
	pakking voor schakelaar OD ø 14mm ID ø 2.5mm dikte 3.5mm wit		

gasthermostaten

SIT

serie 630 Eurosit



1

bestelnr.	101696	fabrikantnr.	R_60249
omschrijving	gasthermostaat type serie 630 Eurosit t.max. 300°C 60-300°C gasingang 3/8" gasuitgang 3/8" thermoelementaansluiting M9x1 waakvlamaansluiting M10x1 voeler ø 4mm voeler L 72mm capillaire 1050mm SIT		
Reparatie-onderdelen voor	101696		
	bestelnr.	101333	fabrikantnr. —
	plug draad 3/8" met o-ring		
Toebehoren voor	101696		
	bestelnr.	100904	fabrikantnr. —
	klenschroef M10x1 voor pijp ø 4mm vpe 1stuk		
	bestelnr.	100905	fabrikantnr. —
	klenschroef M10x1 voor pijp ø 6mm vpe 1stuk		
	bestelnr.	101273	fabrikantnr. —
	snijring voor pijp ø 12mm L 9.5mm koper vpe 1stuk passend voor universeel		
	bestelnr.	101276	fabrikantnr. —
	knelschroef draad 3/8" pijp ø 12mm vpe 1stuk		



gasventielen en branderautomaten







gasregelventielen

SIT

NOVASIT



1

bestelnr.	101956	fabrikantnr.	R_60309
omschrijving	gasventiel SIT serie Novasit 820 230V 50Hz gasingang 1/2" gasuitgang 1/2" thermoelementaansluiting M9x1 waakvlamaansluiting M10x1 ontstekingsdrukbaar drukk bereik 5-50mbar aansluiting voor drukregelaar blind vergelijkings-nr. 0.820.031		
Reparatie-onderdelen voor	101956		
	bestelnr.	101065	fabrikantnr. —
	magneetspoel met kabel L 44mm D1 ø 30mm D2 ø 20mm passend voor NOVASIT		
	bestelnr.	101313	fabrikantnr. —
	magneetspoel 230V 50Hz		
Toebehoren voor	101956		
	bestelnr.	100006	fabrikantnr. —
	piëzo-ontsteker passend voor ELETTROSIT behuizing kunststof drukkend aansluiting ø2,4mm ø 14mm		
	bestelnr.	101305	fabrikantnr. —
	gasaansluiting recht 1/2" flens 45x45mm ELETTROSIT/V4400/4600/4605 passend voor SIT/HONEYWELL LA 36x36mm		
	bestelnr.	101306	fabrikantnr. —
	gasaansluiting haaks flens 45x45mm LA 36x36mm 1/2" ELETTROSIT/V4400/4600/4605 schroefaansluiting met o-ring passend voor SIT/HONEYWELL		
	bestelnr.	101307	fabrikantnr. —
	gasaansluiting recht flens 45x45mm LA 36x36mm 3/4" ELETTROSIT/V4400/4600/4605 schroefaansluiting met o-ring passend voor SIT/HONEYWELL		
	bestelnr.	101308	fabrikantnr. —
	gasaansluiting haaks flens 45x45mm LA 36x36mm 3/4" ELETTROSIT/V4400/4600/4605 schroefaansluiting met o-ring passend voor SIT/HONEYWELL		
	bestelnr.	101312	fabrikantnr. —
	microschakelaar		
	bestelnr.	101314	fabrikantnr. —
	magneetspoel 24V 50Hz		
	bestelnr.	101317	fabrikantnr. —
	stekker met kabel L 1000mm passend voor NOVASIT		

Toebehoren voor	101956		
	bestelnr.	101318	fabrikantnr. —
	afdekkap voor magneetspoel passend voor NOVASIT		

ontstekingstechniek

waakvlambranders

SIT

serie 140 - 145 - 150



1

bestelnr.	107134	fabrikantnr.	R_60354
omschrijving	waakvlambrander SIT type serie 140 1-vlammig sproeier ømm gasaansluitingmm		
Toebehoren voor	107134		
	bestelnr.	100204	fabrikantnr. —
	waakvlaminspuiter SIT flessengas identificatienummer 14 boring ø 0,18/0,20mm vpe 1stuk passend voor serie 140		
	bestelnr.	100205	fabrikantnr. —
	waakvlaminspuiter SIT flessengas identificatienummer 19 boring ø 0,23/0,26mm vpe 1stuk passend voor SIT serie 150		
	bestelnr.	100206	fabrikantnr. —
	waakvlaminspuiter SIT aardgas identificatienummer 36 boring ø 0,60/0,55mm passend voor SIT serie 150		
	bestelnr.	100207	fabrikantnr. —
	waakvlaminspuiter SIT aardgas identificatienummer 27 boring ø 0,40/0,38mm passend voor SIT serie 140		
	bestelnr.	100216	fabrikantnr. —
	waakvlaminspuiter SIT aardgas identificatienummer 38 boring ø 0,45mm vpe 1stuk passend voor SIT serie 150		
	bestelnr.	100701	fabrikantnr. —
	bougie aansluiting M4 vpe 1stuk		
	bestelnr.	100897	fabrikantnr. —
	snijring voor pijpø 4mm vpe 1stuk voor ontstekingsbrander		
	bestelnr.	100898	fabrikantnr. —
	snijring voor pijpø 6mm vpe 1stuk voor ontstekingsbrander		
	bestelnr.	100906	fabrikantnr. —
	schroefconnectie draad M10x1 voor ontstekingsselektrode koper vpe 1stuk SB 10		
	bestelnr.	100907	fabrikantnr. —
	schroefconnectie draad M10x1 vpe 1stuk type SEF 1 ømm voor thermokoppel		
	bestelnr.	100908	fabrikantnr. —
	knelschroef draad M10x1 voor pijpø 4mm vpe 1stuk		
	bestelnr.	100909	fabrikantnr. —
	knelschroef draad M10x1 voor pijpø 6mm vpe 1stuk		

	
bestelnr.	107132 fabrikantnr. 111003
omschrijving	waakvlambrander SIT type serie 140 2-vlammig sproeier ømm gasaansluitingmm
Toebehoren voor	107132
	bestelnr. 100204 fabrikantnr. — waakvlaminspuiters SIT flessengas identificatienummer 14 boring ø 0,18/0,20mm vpe 1stuk passend voor serie 140
	bestelnr. 100205 fabrikantnr. — waakvlaminspuiters SIT flessengas identificatienummer 19 boring ø 0,23/0,26mm vpe 1stuk passend voor SIT serie 150
	bestelnr. 100206 fabrikantnr. — waakvlaminspuiters SIT aardgas identificatienummer 36 boring ø 0,60/0,55mm vpe 1stuk passend voor SIT serie 150
	bestelnr. 100207 fabrikantnr. — waakvlaminspuiters SIT aardgas identificatienummer 27 boring ø 0,40/0,38mm passend voor SIT serie 140
	bestelnr. 100216 fabrikantnr. — waakvlaminspuiters SIT aardgas identificatienummer 38 boring ø 0,45mm vpe 1stuk passend voor SIT serie 150
	bestelnr. 100701 fabrikantnr. — bougie aansluiting M4 vpe 1stuk
	bestelnr. 100897 fabrikantnr. — snijring voor pijpø 4mm vpe 1stuk voor ontstekingsbrander
	bestelnr. 100898 fabrikantnr. — snijring voor pijpø 6mm vpe 1stuk voor ontstekingsbrander
	bestelnr. 100906 fabrikantnr. — schroefconnectie draad M10x1 voor ontstekingselektrode koper vpe 1stuk SB 10
	bestelnr. 100907 fabrikantnr. — schroefconnectie draad M10x1 vpe 1stuk type SEF 1 ømm voor thermokoppel
	bestelnr. 100908 fabrikantnr. — knelschroef draad M10x1 voor pijpø 4mm vpe 1stuk
	bestelnr. 100909 fabrikantnr. — knelschroef draad M10x1 voor pijpø 6mm vpe 1stuk
	bestelnr. 102110 fabrikantnr. — waakvlamleiding koper pijp ø 4mm dikte 1mm L 3000mm
	bestelnr. 102111 fabrikantnr. — waakvlamleiding koper pijp ø 6mm dikte 1mm L 3000mm

ontstekingskabels

ontstekingskabels

	
bestelnr.	100016 fabrikantnr. R_110263
omschrijving	ontstekingskabel kabellengte 900mm aansluiting ø2,4mm / ø2,4mm

piëzo-ontstekers

inbouwdiameter 18mm

	
bestelnr.	100009 fabrikantnr. R_60829
omschrijving	piëzo-ontsteker behuizing kunststof drukkend inbouw ø 18mm aansluiting ø2,4mm voorkant maat 26mm M18x1,5
Toebehoren voor	100009
	bestelnr. 101339 fabrikantnr. — afdekkap voor piëzo-ontsteker
	bestelnr. 106869 fabrikantnr. — afdekkap voor piëzo-ontsteker ID ø 22mm OD ø 35mm H 25mm
	bestelnr. 107931 fabrikantnr. — afdekkap voor piëzo-ontsteker ID ø 21mm OD ø 36mm

thermokoppels

insteekthermokoppels

insteekthermokoppels standaard

met steekhuls ø6(6,5)mm

thermokoppels SIT

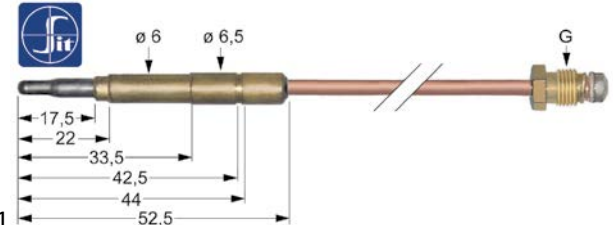
	
bestelnr.	107614 fabrikantnr. R_61061
omschrijving	thermokoppel SIT M9x1 L 1500mm steekhuls ø6,0(6,5)mm

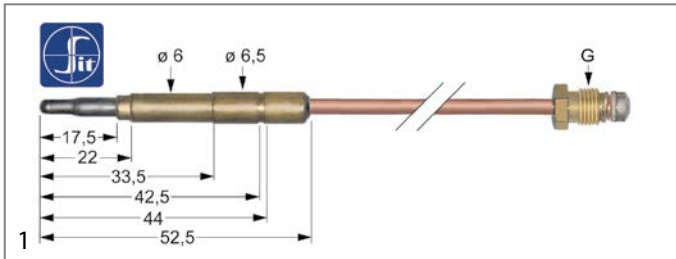

bestelnr.	107610	fabrikantnr.	R_61060
omschrijving	thermokoppel SIT M9x1 L 750mm steekhuls $\varnothing 6,0(6,5)$ mm		

insteekthermokoppels met onderbreking

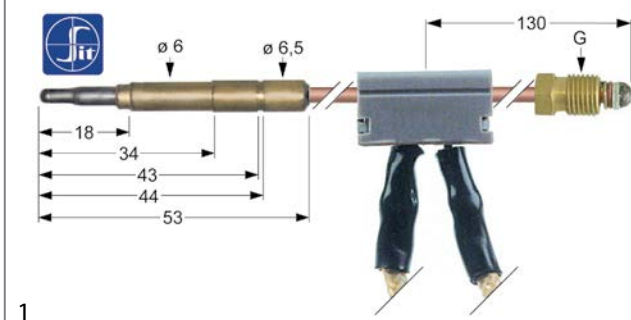

bestelnr.	107863	fabrikantnr.	R_62398
omschrijving	thermokoppel SIT met onderbreker M9x1 L 1000mm steekhuls $\varnothing 6,0(6,5)$ mm Kabel 820mm		

toebehoren

schroeven



bestelnr.	102464	fabrikantnr.	R_61079
omschrijving	thermokoppelhoer draad M10x1 koper vpe 1stuk		

korven

pastakorven

DESCO



bestelnr.	970568	fabrikantnr.	CD044
omschrijving	pastakorf L1 165mm B1 304mm H1 204mm grootte GN 1/3 RVS		



bestelnr.	970569	fabrikantnr.	CD045
omschrijving	pastakorf L1 242mm B1 304mm H1 204mm grootte GN 1/2 RVS		



bestelnr.	970567	fabrikantnr.	CD043
omschrijving	pastakorf L1 304mm B1 165mm H1 204mm grootte GN 1/3 RVS		



bestelnr.	970570	fabrikantnr.	CD046
omschrijving	pastakorf L1 480mm B1 305mm H1 180mm grootte GN 1/1 RVS		



bestelnr.	970429	fabrikantnr.	CD047
omschrijving	pastakorf \varnothing 145mm H1 205mm H3 370mm RVS		



1

bestelnr.	970571	fabrikantnr.	CD048
omschrijving	opleegrooster L 475mm B 250mm H 110mm RVS passend voor pastakoker		

rubbers

thermische pakkingen

deurrubbers met bevestigingshaken



1

bestelnr.	692546 ¹	fabrikantnr.	60045
omschrijving	deurrubber L 255mm B 630mm 3-zijdig lange zijde open met 6 bevestigingshaken		

¹3-zijdig, lange zijde open

verdampers

voor koelkasten

fabrikantspecifiek



1

bestelnr.	750450	fabrikantnr.	R_19619
omschrijving	verdampers L 490mm H 70mm B 395mm voor koelkast passend voor ILSA		

ventielen en containerinlaten

afsluitkranen

universeel



1

bestelnr.	540935	fabrikantnr.	110120	
omschrijving	afsluitkraan aansluiting buis ø 10mm totale lengte 110mm as 7x7mm			
Toehoren voor	540935			
	bestelnr.	110287	fabrikantnr.	—
	knop water t.max.°C instelbereik°C ø 50mm as ø 7x7mm afvlakking zwart			



1

bestelnr.	541982	fabrikantnr.	115120	
omschrijving	schuif aansluiting 1/2" ID - 1/2" ID bevestigingsdraad M27x1,5			
Toehoren voor	541982			
	bestelnr.	547713	fabrikantnr.	—
	kruisgreep asafname ø 8mm markering blauw type F passend voor MONOLITH			

A

afsluitkranen 8

D

deurrubbers met bevestigingshaken 8

drukschakelaar/-knoppen 4

E

elementen voor salamanders en toasters 3

G

gasregelventielen 5

gasthermostaten 4

K

kookplaten 3

M

maximaal thermostaten 3

N

nokkenschakelaars 4

O

ontstekingskabels 6

P

piëzo-ontstekers 6

R

regelthermostaten 3

S

schakelaars en tasters 4

stralingselementen 3

T

thermische pakkingen 8

thermokoppels 6

thermostaten 3

V

ventielen en containerinlaten 8

verdampers 8

verwarmingselementen 3

W

waakvlambranders 5