



GAS



ELEKTRA



WATER



MECHANIEK



GEREEDSCHAP

Reparatie-onderdelen passend voor

FRYLAND

Het complete assortiment vindt u altijd up-to-date in onze webshop



Fabrikant-catalogussen

Per fabrikant de belangrijkste vervangingsonderdelen en toebehoren overzichtelijk bij elkaar

- ✓ **Compleet assortiment en altijd de actuele apparatuurgegevens in de GEV-Webshop**
- ✓ **Alfabetische Index achter in de catalogus**

GEV-Webshop

www.gev-online.nl



- 🔍 **Artikel als favoriet opslaan**
- 🔍 **Inloggen met E-mailadres en bekende paswoord**
- 🔍 **Bulk bestellen - meerdere artikelen direct in de winkelwagen laden**
- 🔍 **Direct op artikel zoeken zonder je hoeven aan te melden**





















gasthermostaten

SIT

serie 710 Minisit



bestelnr.	101135	fabrikantnr.	03137
omschrijving	gasthermostaat SIT type MINISIT 710 t.max. 190°C 110-190°C gasingang 1/2" gasuitgang 3/8" thermoelementaansluiting M9x1 waakvlamaansluiting M10x1 voeler ø 6mm voeler L 102mm capillaire 1050mm sensortype type A3 drukregelaar nee drukregelaarmbar stopbus		
Voor modellen:	Lt15+15g-ce		
Reparatie-onderdelen voor	101135		
	bestelnr.	101053	fabrikantnr. —
	magneetspoel Dr.G1: M9x1 Dr.G2: M24x1 L 45mm ø 17mm passend voor Minisit		
	bestelnr.	102118	fabrikantnr. —
	voeler 110-190°C voeler ø 6mm voeler L 102mm capillaire 1050mm t.max. 190°C friteuse sensortype type A3 passend voor MINISIT 710		
Toebehoren voor	101135		
	bestelnr.	100809	fabrikantnr. —
	O-ring EPDM materiaaldikte 2mm ID ø 21mm vpe 1stuk		
	bestelnr.	100820	fabrikantnr. —
	stopbusdoorvoering OD M14x1,5 BD M10x0,75 voeler ø max. 6.5mm SB 22		
	bestelnr.	100904	fabrikantnr. —
	klemschroef M10x1 voor pijpø 4mm vpe 1stuk		
	bestelnr.	100905	fabrikantnr. —
	klemschroef M10x1 voor pijpø 6mm vpe 1stuk		
	bestelnr.	101054	fabrikantnr. —
	magneetspoel Dr.G1: M10x1 Dr.G2: M24x1 L 45mm ø 17mm passend voor Minisit		
	bestelnr.	101136	fabrikantnr. —
	piëzo-ontsteker passend voor Minisit met afdekkap ømm aansluiting F6,3x0,8		
	bestelnr.	101137	fabrikantnr. —
	afdekkap zonder piëzo-ontsteker		
	bestelnr.	101267	fabrikantnr. —
	reducer BD 3/8" OD 1/2" L 21mm		
	bestelnr.	101268	fabrikantnr. —
	gasaansluiting draad 3/8" haaks met o-ring MINISIT 710		
	bestelnr.	101269	fabrikantnr. —
	gasaansluiting draad 1/2" haaks met o-ring MINISIT 710		
	bestelnr.	101270	fabrikantnr. —
	schroefconnectie BD 3/8" OD 3/8" L 28mm		

Toebehoren voor	101135		
	bestelnr.	101272	fabrikantnr. —
	schroefconnectie BD 1/2" OD 3/8" L 57mm		
	bestelnr.	101273	fabrikantnr. —
	snijring voor pijpø 12mm L 9.5mm koper vpe 1stuk passend voor universeel		
	bestelnr.	101274	fabrikantnr. —
	snijring voor pijpø 16mm vpe 1stuk		
	bestelnr.	101275	fabrikantnr. —
	knelschroef draad 1/2" voor pijpø 16mm vpe 1stuk		
	bestelnr.	101276	fabrikantnr. —
	knelschroef draad 3/8" pijp ø 12mm vpe 1stuk		
	bestelnr.	110068	fabrikantnr. —
	knop passend voor Minisit ø 37mm		







ontstekingstechniek

waakvlambranders

SIT

serie 100



bestelnr.	107139	fabrikantnr.	03139
omschrijving	waakvlambrander SIT type serie 100 1-vlammig sproeier ø 0.2mm gasaansluitingmm		
Voor modellen:	Lt15+15g-ce		
Reparatie-onderdelen voor	107139		
	bestelnr.	100854	fabrikantnr. —
	waakvlambranderhouder dubbel		
	bestelnr.	100885	fabrikantnr. —
	menghuls voor ontstekingsbrander vpe 1stuk		
	bestelnr.	107160	fabrikantnr. —
	waakvlambrander bovendeel SIT 1-vlammig Hmm Lmm vpe 1stuk		
Toebehoren voor	107139		
	bestelnr.	100904	fabrikantnr. —
	klemschroef M10x1 voor pijpø 4mm vpe 1stuk		
	bestelnr.	100905	fabrikantnr. —
	klemschroef M10x1 voor pijpø 6mm vpe 1stuk		
	bestelnr.	100998	fabrikantnr. —
	waakvlambranderonderstuk sproeier ø 0.21mm passend voor serie 100		
	bestelnr.	102110	fabrikantnr. —
	waakvlamleiding koper pijp ø 4mm dikte 1mm L 3000mm		

Tabel wordt vervolgd op de volgende pagina



Toebehoren voor	107139			
	bestelnr.	102111	fabrikantnr.	—
	waakvlamleiding koper pijp ø 6mm dikte 1mm L 3000mm			

POLIDORO

waakvlambranders









bestelnr.	100076	fabrikantnr.	03479
omschrijving	waakvlambrander POLIDORO 3-vlammig aardgas identificatienummer 29.2 gasaansluiting 6mm		
Voor modellen:	SC6FG		
Reparatie-onderdelen voor	100076		



bestelnr.	100907	fabrikantnr.	—
schroefconnectie draad M10x1 vpe 1 stuk type SEF 1 ømm voor thermokoppel			



Toebehoren voor	100076			
	bestelnr.	100000	fabrikantnr.	—
	bestelnr.	100208	fabrikantnr.	—
	bestelnr.	100209	fabrikantnr.	—
	bestelnr.	100701	fabrikantnr.	—
	bestelnr.	100906	fabrikantnr.	—
	bestelnr.	100907	fabrikantnr.	—
	bestelnr.	100908	fabrikantnr.	—
	bestelnr.	100909	fabrikantnr.	—
	bestelnr.	102110	fabrikantnr.	—
	bestelnr.	102111	fabrikantnr.	—
	bestelnr.	102508	fabrikantnr.	—
	bestelnr.	102509	fabrikantnr.	—
	bestelnr.	102699	fabrikantnr.	—

Toebehoren voor	100076			
	bestelnr.	102795	fabrikantnr.	—
	bestelnr.	102797	fabrikantnr.	—
	bestelnr.	106703	fabrikantnr.	—
	bestelnr.	106704	fabrikantnr.	—
	bestelnr.	106763	fabrikantnr.	—
	bestelnr.	106859	fabrikantnr.	—

piëzo-ontstekers

diversen





bestelnr.	107517	fabrikantnr.	03288	
omschrijving	piëzo-ontsteker passend voor Minisit aansluiting F6,3x0,8 met afdekkap ø 22mm			
Reparatie-onderdelen voor	107517			
	bestelnr.	107564	fabrikantnr.	—
Toebehoren voor	107517			
	bestelnr.	100025	fabrikantnr.	—

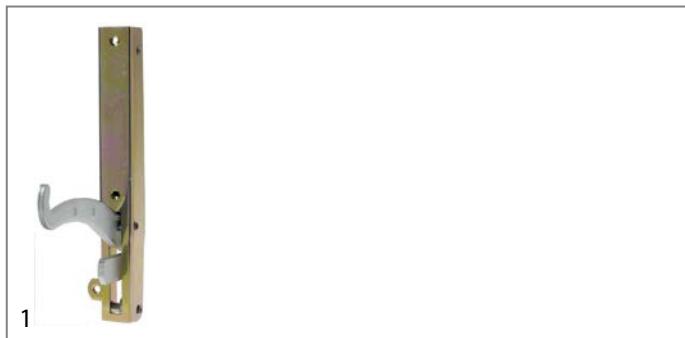

scharnieren
ovenscharnieren



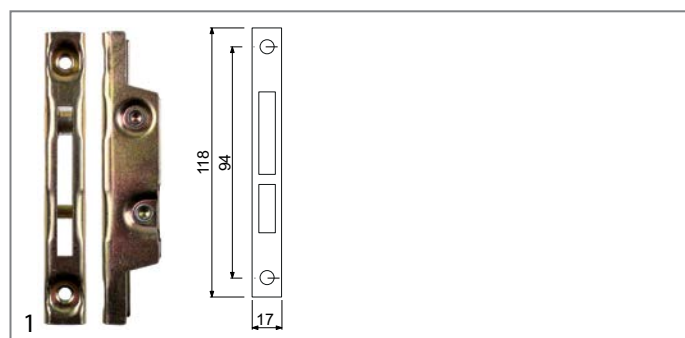

bestelnr.	700006	fabrikantnr.	03478D
omschrijving	ovenscharnier bevestigingsafstand 173mm bevestigingsafstand 2 105mm lasbevestiging 14mm hendellengte 120mm gleufafstand 11mm veerdikte 3.5mm bevestigingskant links veerlengte 112mm B 25mm		
Toebehoren voor	700006		
	bestelnr.	700001	fabrikantnr. 03808c
	tegenhouder L 118mm B 17mm bevestigingsafstand 94mm		
	bestelnr.	700007	fabrikantnr. 03478s
	ovenscharnier bevestigingsafstand 173mm bevestigingsafstand 2 105mm lasbevestiging 14mm hendellengte 120mm gleufafstand 11mm veerdikte 3.5mm bevestigingskant rechts veerlengte 112mm B 25mm		

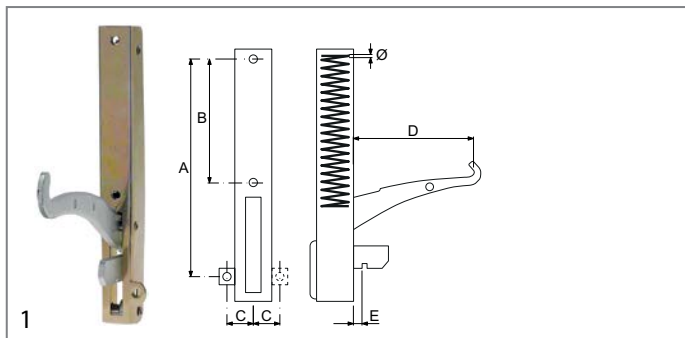

bestelnr.	700001	fabrikantnr.	03808c
omschrijving	tegenhouder L 118mm B 17mm bevestigingsafstand 94mm		



bestelnr.	700007	fabrikantnr.	03478s
omschrijving	ovenscharnier bevestigingsafstand 173mm bevestigingsafstand 2 105mm lasbevestiging 14mm hendellengte 120mm gleufafstand 11mm veerdikte 3.5mm bevestigingskant rechts veerlengte 112mm B 25mm		
Toebehoren voor	700007		
	bestelnr.	700001	fabrikantnr. 03808c
	tegenhouder L 118mm B 17mm bevestigingsafstand 94mm		
	bestelnr.	700006	fabrikantnr. 03478D
	ovenscharnier bevestigingsafstand 173mm bevestigingsafstand 2 105mm lasbevestiging 14mm hendellengte 120mm gleufafstand 11mm veerdikte 3.5mm bevestigingskant links veerlengte 112mm B 25mm		

G

gasthermostaten 3

O

ovenscharnieren 5

P

piëzo-ontstekers 4

W

waakvlambranders 3