



GAS



ELEKTRA



WATER



MECHANIEK



GEREEDSCHAP

Reparatie-onderdelen passend voor

ITALCREM

Het complete assortiment vindt u altijd up-to-date in onze webshop



Fabrikant-catalogussen

Per fabrikant de belangrijkste vervangingsonderdelen en toebehoren overzichtelijk bij elkaar

- ✓ **Compleet assortiment en altijd de actuele apparatuurgegevens in de GEV-Webshop**
- ✓ **Alfabetische Index achter in de catalogus**

GEV-Webshop

www.gev-online.nl



- 🔍 **Artikel als favoriet opslaan**
- 🔍 **Inloggen met E-mailadres en bekende paswoord**
- 🔍 **Bulk bestellen - meerdere artikelen direct in de winkelwagen laden**
- 🔍 **Direct op artikel zoeken zonder je hoeven aan te melden**



verwarmingselementen



elementen voor koffiemachines

1 			
bestelnr.	417121	fabrikantnr.	N/A
omschrijving	verwarmingselement 1000W 230V inbouw ø 42mm L 406mm VC 1 aansluiting M6 LA 55mm gat ø 10mm B 39mm H 40mm dompel verwarmingselement pijp ø 8mm 3-gatsflens L1 40mm L2 50mm L3 316mm passend voor ITALCREM, VISACREM		

1 			
bestelnr.	417123	fabrikantnr.	N/A
omschrijving	verwarmingselement 1250W 230V inbouw ø 42mm L 580mm VC 1 aansluiting M6 LA 56mm gat ø 10mm B 40mm H 43mm dompel verwarmingselement pijp ø 8mm 3-gatsflens L1 45mm L2 45mm L3 490mm passend voor ITALCREM, VISACREM H1 8mm H2 35mm		



1 			
bestelnr.	417066	fabrikantnr.	N/A
omschrijving	verwarmingselement 1300W 400V VC 1 dompel verwarmingselement		

1 			
bestelnr.	417122	fabrikantnr.	N/A
omschrijving	verwarmingselement 1500W 230V inbouw ø 42mm L 400mm VC 1 aansluiting M6 LA 55mm gat ø 10mm B 42mm H 44mm dompel verwarmingselement pijp ø 8mm 3-gatsflens H1 9mm H2 35mm L1 45mm L2 50mm L3 315mm passend voor ITALCREM, VISACREM		

1 			
bestelnr.	417120	fabrikantnr.	N/A
omschrijving	verwarmingselement 1500W 230V VC 1 inbouw ø 42mm LA 56mm L 190mm B 20mm H 40mm gat ø 9mm aansluiting M6x1 dompel verwarmingselement 3-gatsflens passend voor ITALCREM, VISACREM		
Toebehoren voor	417120		
	bestelnr.	528008	fabrikantnr. —
	pakking ID ø 30mm fiber materiaaldikte 3mm gat ø 9mm LA 44mm voor verwarmingselement koffietechniek		

1 			
bestelnr.	417116	fabrikantnr.	N/A
omschrijving	verwarmingselement 1800W 230V VC 2 inbouw ø 42mm LA 74mm L 240mm B 36mm H 44mm L1 25mm L2 40mm L3 173mm H1 31mm H2 12mm gat ø 9mm pijp ø 8.5mm thermostaathuls ø 6mm thermostaathuls lengte 205mm thermostaathuls niet-aangrenzend aantal thermostaathulzen 1 aansluiting M4 dompel verwarmingselement 2-gatsflens		

1 			
bestelnr.	417124	fabrikantnr.	N/A
omschrijving	verwarmingselement 2500W 230V inbouw ø 42mm L 545mm VC 1 aansluiting M6 LA 57mm gat ø 10mm B 40mm H 42mm dompel verwarmingselement pijp ø 8mm 3-gatsflens L1 45mm L2 45mm L3 455mm passend voor ITALCREM, VISACREM H2 20mm		

1 			
bestelnr.	417001	fabrikantnr.	02212439
omschrijving	verwarmingselement 2600W 230V VC 2 inbouw ø 42mm LA 74mm L 330mm B 30mm H 60mm L1 23mm L2 65mm L3 202mm H1 30mm H2 30mm gat ø 12mm pijp ø 8.5mm thermostaathuls ø 7mm thermostaathuls lengte 195mm thermostaathuls buitenmidden, niet aanliggend aantal thermostaathulzen 1 aansluiting M6 dompel verwarmingselement 2-gatsflens		
Toebehoren voor	417001		
	bestelnr.	528002	fabrikantnr. N/A
	vlakpakking PTFE OD ø 57mm ID ø 42mm materiaaldikte 3mm vpe 1stuk vergelijkingsnr. 12001/W10470 passend voor		
	bestelnr.	528488	fabrikantnr. —
	vlakpakking fiber OD ø 57mm ID ø 42mm materiaaldikte 3mm vpe 1stuk		

toebehoren

asafdichtingen

PTFE-pakkingen

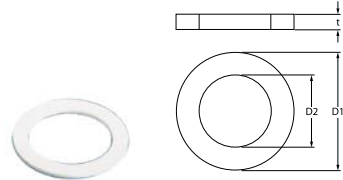
1 			
bestelnr.	528002	fabrikantnr.	N/A
omschrijving	vlakpakking PTFE OD ø 57mm ID ø 42mm materiaaldikte 3mm vpe 1stuk vergelijkingsnr. 12001/W10470 passend voor		

flenspakkingen

1 			
bestelnr.	528740	fabrikantnr.	N/A
omschrijving	pakking ID ø 44mm PTFE materiaaldikte 3.5mm gat ø 9.5mm LA 58mm passend voor ITALCREM, VISACREM voor verwarmingselement koffietechniek		

pompen

drukverhogingspompen II

pompkoppen

FLUID-O-TECH



1

bestelnr.	500064	fabrikantnr.	07822109
omschrijving	pompkop PO204 FLUID-O-TECH L 82mm 200l/h aansluiting 3/8" GAS met bypass koper klemaansluiting voor koffiemachine as ø 4,8x11mm		
Toebehoren voor	500064		
	bestelnr.	520126	fabrikantnr. —
	klembeugel voor pompmotor		

apparaatspecifieke bouwdeelen voor espressomachines

broeigroepen

zeefhouder pakkingen

vlak

standaard



1

bestelnr.	528058	fabrikantnr.	N/A
omschrijving	zeefhouderpakking D1 ø 71mm D2 ø 56.9mm H 10.2mm vpe 1stuk		

expansieventielen



1

bestelnr.	529317	fabrikantnr.	N/A
omschrijving	expansieventiel Dr.G1: 1/4" OD Dr.G2: 1/4" ID L 58mm		

boilers

rubbers

geperforeerd



1

bestelnr.	528166	fabrikantnr.	N/A
omschrijving	boilerpakking D1 ø 200mm D2 ø 160mm materiaaldikte 3mm 10gaten fiber passend voor ITALCREM, VISACREM		

rubbers

asafdichtingen

PTFE-pakkingen



1

bestelnr.	528002	fabrikantnr.	N/A
omschrijving	vlakpakking PTFE OD ø 57mm ID ø 42mm materiaaldikte 3mm vpe 1stuk vergelijkingsnr. 12001/W10470 passend voor		

speciale rubbers

groep pakkingen



1

bestelnr.	528173	fabrikantnr.	N/A
omschrijving	groepdichting		

manometers



1

bestelnr.	541789	fabrikantnr.	N/A
omschrijving	manometer ø 50mm drukbereik 0 tot 12bar draad 1/4" markering 2-2,4 aansluiting keerzijde		



 <p>1</p>			
bestelnr.	541245	fabrikantnr.	N/A
omschrijving	manometer ø 50mm drukk bereik 0 tot 24bar draad 1/4" markering 8-10 aansluiting keerzijde		

 <p>1</p>			
bestelnr.	541244	fabrikantnr.	N/A
omschrijving	manometer ø 52mm drukk bereik 0 tot 3bar draad 1/4" markering 1,1-1,3 aansluiting keerzijde		

 <p>1</p>			
bestelnr.	541243	fabrikantnr.	N/A
omschrijving	manometer ø 52mm drukk bereik 0 tot 24bar draad 1/4" markering 8-10 aansluiting keerzijde		

 <p>1</p>			
bestelnr.	541242	fabrikantnr.	N/A
omschrijving	manometer ø 52mm drukk bereik 0 tot 3bar draad 1/4" markering 1,1-1,3 aansluiting keerzijde		

A

asafdichtingen 4

D

drukverhogingspompen II 4

E

elementen voor koffiemachines 3

P

pompen 4

V

verwarmingselementen 3