



GAS



ELEKTRA



WATER



MECHANIEK



GEREEDSCHAP

Reparatie-onderdelen passend voor

ROKA

Het complete assortiment vindt u altijd up-to-date in onze webshop



Fabrikant-catalogussen

Per fabrikant de belangrijkste vervangingsonderdelen en toebehoren overzichtelijk bij elkaar

- ✓ **Compleet assortiment en altijd de actuele apparatuurgegevens in de GEV-Webshop**
- ✓ **Alfabetische Index achter in de catalogus**

GEV-Webshop

www.gev-online.nl



- 🔍 **Artikel als favoriet opslaan**
- 🔍 **Inloggen met E-mailadres en bekende paswoord**
- 🔍 **Bulk bestellen - meerdere artikelen direct in de winkelwagen laden**
- 🔍 **Direct op artikel zoeken zonder je hoeven aan te melden**



verwarmingselementen

elementen voor bain maries

bestelnr.	415323	fabrikantnr.	8900322
omschrijving	verwarmingselement 1600W 230V VC 1 L 383mm B 96mm flens L 45mm flens B 12mm LA 36mm pijp ø 6.3mm kabel- lengte 290mm rechthoekige flens gat ø M5mm droog ver- warmingselement L1 14mm L2 369mm B1 72mm B2 24mm		

bestelnr.	415675	fabrikantnr.	14181 8900342
omschrijving	verwarmingselement 2000W 230V L 250mm B 100mm aansluiting vlaksteker 6,3mm pijp ø 8.5mm 2-gatsbevesti- ging draad M14x1,5 dompel verwarmingselement H 26mm bevestigingsafstand 92mm		

bestelnr.	415669	fabrikantnr.	14997 8900324
omschrijving	verwarmingselement 2000W 230V VC 1 L 452mm B 256mm aansluiting vlaksteker 6,3mm pijp ø 6.3mm 2-gatsbevesti- ging draad M10x1 dompel verwarmingselement B1 59mm B2 138mm H 16mm bevestigingsafstand 132mm		
Toebehoren voor	415669		
	bestelnr.	510902	fabrikantnr.
	O-ring EPDM materiaaldikte 2mm ID ø 9.5mm vpe 1stuk		

bestelnr.	415375	fabrikantnr.	10982 8900341
omschrijving	verwarmingselement 3000W 230V L 257mm B 165mm aansluiting vlaksteker 6,3mm pijp ø 8.5mm 2-gatsbevesti- ging draad M14x1,5 dompel verwarmingselement H 28mm bevestigingsafstand 158mm		
Toebehoren voor	415375		
	bestelnr.	510417	fabrikantnr.
	vlakpakking fiber OD ø 20mm ID ø 14mm materiaaldikte 2mm vpe 1stuk		
	bestelnr.	520228	fabrikantnr.
	tandring ID ø 15.3mm OD ø 24mm staal vpe 1stuk voor draad M14		
	bestelnr.	520230	fabrikantnr.
	moer draad M14x1,5 H 5mm SB 19 verzinkt staal vpe 1stuk		

Toebehoren voor	415375		
	bestelnr.	521101	fabrikantnr.
	moer draad M14x1,5 H 5mm SB 19 RVS vpe 1stuk		
	bestelnr.	550262	fabrikantnr.
	vlakpakking koper OD ø 20mm ID ø 14mm materiaaldikte 2mm		

bestelnr.	415672	fabrikantnr.	13653 8900325
omschrijving	verwarmingselement 3000W 230V L 452mm B 254mm aansluiting 6.3 pijp ø 6.3mm 2-gatsbevestiging draad M10x1 dompel verwarmingselement B1 60mm B2 136mm H 20mm bevestigingsafstand 130mm		

elementen voor friteuses

tweegatsbevestiging



bestelnr.	415365	fabrikantnr.	8900332 8900322, 215mm
omschrijving	verwarmingselement 3300W 220V VC 1 L 310mm B 170mm H 215mm L1 70mm L2 240mm inbouwpositie buiten draad M14x1,5 bevestigingsafstand 162mm pijp ø 8.5mm windin- gen 4 2-gatsbevestiging aansluiting vlaksteker 6,3mm		

bestelnr.	415366	fabrikantnr.	8900332 8900332, 235mm
omschrijving	verwarmingselement inbouwpositie binnenkant 3300W 220V VC 1 L 325mm B 175mm H 240mm L1 82mm L2 245mm draad M14x1,5 bevestigingsafstand 156mm pijp ø 8.5mm windingen 4 2-gatsbevestiging aansluiting vlakste- ker 6,3mm aansluitingslengte 35mm dompel verwarmings- element		
Toebehoren voor	415366		
	bestelnr.	510417	fabrikantnr.
	vlakpakking fiber OD ø 20mm ID ø 14mm materiaaldikte 2mm vpe 1stuk		
	bestelnr.	520228	fabrikantnr.
	tandring ID ø 15.3mm OD ø 24mm staal vpe 1stuk voor draad M14		

Tabel wordt vervolgd op de volgende pagina



→ elektra componenten

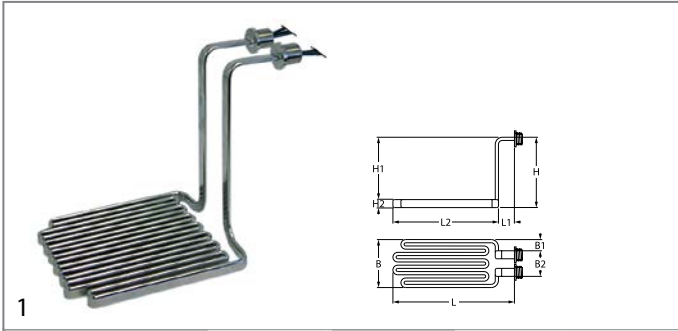

Toebehoren voor	415366			
	bestelnr.	520230	fabrikantnr.	—
	moer draad M14x1,5 H 5mm SB 19 verzinkt staal vpe 1stuk			
	bestelnr.	521101	fabrikantnr.	—
	moer draad M14x1,5 H 5mm SB 19 RVS vpe 1stuk			
	bestelnr.	550262	fabrikantnr.	—
	vlakpakking koper OD ø 20mm ID ø 14mm materiaaldikte 2mm			



bestelnr.	415792	fabrikantnr.	8900350
omschrijving	verwarmingselement 6000W 230/400V VC 3 L 290mm B 198mm H 245mm L1 65mm L2 225mm B1 62mm B2 74mm H1 228mm H2 17mm kabellengte 140mm 2-gatsbevestiging draad 3/4" aansluiting kabel friteuse element		

Toebehoren voor	415792			
	bestelnr.	510403	fabrikantnr.	—
	vlakpakking fiber OD ø 36.5mm ID ø 27mm materiaaldikte 2mm vpe 1stuk			
	bestelnr.	510421	fabrikantnr.	—
	pakking koper OD ø 31.8mm ID ø 26.4mm materiaaldikte 2.2mm voor draad 3/4"			
	bestelnr.	520234	fabrikantnr.	—
	moer draad 3/4" H 5mm koper SB 30 vpe 1stuk			

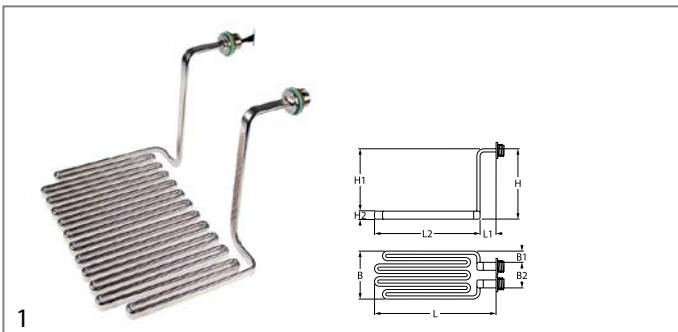

bestelnr.	418237	fabrikantnr.	8900351
omschrijving	verwarmingselement 9900W 400V VC 3 L 326mm B 342mm H 242mm L1 68mm L2 248mm B1 65mm B2 213mm H1 225mm H2 17mm aansluitingslengte 32mm kabellengte 135mm 2-gatsbevestiging draad M26x1,5 bevestigingsafstand 196mm dompel verwarmingselement		

elementen voor grills

bestelnr.	415676	fabrikantnr.	8900326
omschrijving	verwarmingselement 400W 230V VC 1 L 465mm B 8.5mm H 8.5mm droog verwarmingselement aansluiting M4 pijp ø 8.5mm		

bestelnr.	418234	fabrikantnr.	8900323
omschrijving	verwarmingselement 1200W 230V VC 1 L 385mm B 70mm L1 15mm B2 24mm flens L 46mm flens B 17mm LA 36mm aansluitingslengte 55mm pijp ø 6.5mm rechthoekige flens kabellengte 335mm draad M5 droog verwarmingselement		

elementen voor warmtekasten

bestelnr.	415323	fabrikantnr.	8900322
omschrijving	verwarmingselement 1600W 230V VC 1 L 383mm B 96mm flens L 45mm flens B 12mm LA 36mm pijp ø 6.3mm kabel-lengte 290mm rechthoekige flens gat ø M5mm droog verwarmingselement L1 14mm L2 369mm B1 72mm B2 24mm		

hetelucht elementen

bestelnr.	418240	fabrikantnr.	8900327		
omschrijving	verwarmingselement 1300W 230V VC 1 ID ø 194mm OD ø 207mm L 217mm H 28mm L1 10mm B1 31mm H1 10mm H2 19mm flens L 70mm flens B 22mm LA 56mm aansluiting vlaksteker 6,3mm aansluitingslengte 37mm pijp ø 6.3mm rond verwarmingselement gat ø 6.2mm rechthoekige flens				
Toebehoren voor	418240	bestelnr.	510368	fabrikantnr.	—
		pakking L 70mm B 23.5mm gat ø 5mm LA 56mm FIBER materiaaldikte 2mm voor verwarmingselement			

toebehoren

capilaire pijp klemmen			
bestelnr.	550004	fabrikantnr.	8900541
omschrijving	capilairklem voor pijp ø 17x6mm voor vlakke pijpverwarmer		



klembeugels			
			
bestelnr.	550043	fabrikantnr.	8900521 8999998
omschrijving	voelerklem voor pijp ø 17x6mm voor voeler ø 6mm vpe 1stuk		

Toebehoren voor	375005		
	bestelnr.	110240	fabrikantnr.
	knop thermostaat t.max. 85°C ø 50mm as ø 6x4,6mm afvlakking boven zwart instelbereik 30-85°C		

thermostaten

regel- en maximaalthermostaten

EGO

regelthermostaten



Serie 55.13_

			
bestelnr.	375007	fabrikantnr.	8900202
omschrijving	thermostaat t.max. 110°C instelbereik 30-110°C 1-polig 1NO 16A voeler ø 6mm voeler L 113mm capillaire 870mm capillaire pijp geïsoleerdmm stopbus M9x1 as L 25mm aspositie boven rotatiehoek 270°		
Toebehoren voor	375007		
	bestelnr.	110119	fabrikantnr.
	knop thermostaat t.max. 110°C ø 50mm as ø 6x4,6mm afvlakking boven zwart instelbereik 30-110°C rotatiehoek 270°		
	bestelnr.	110241	fabrikantnr.
	knop thermostaat t.max. 110°C ø 50mm as ø 6x4,6mm afvlakking boven zwart instelbereik 30-110°C		

serie 55.34_

			
bestelnr.	375512	fabrikantnr.	8900210
omschrijving	thermostaat t.max. 185°C instelbereik 95-185°C 3-polig 3NO 16A voeler ø 6mm voeler L 133mm capillaire 2430mm capillaire pijp geïsoleerd 1100mm stopbus M9x1 as ø 6x4,6mm as L 23mm aspositie boven rotatiehoek 270°		

bestelnr.	375693	fabrikantnr.	8900211
omschrijving	thermostaat t.max. 250°C instelbereik 48-250°C 3-polig 3NO 16A voeler ø 3.1mm voeler L 226mm capillaire 880mm capillaire pijp geïsoleerd 850mm stopbus as ø 6x4,6mm as L 23mm aspositie boven rotatiehoek 318°		

bestelnr.	375005	fabrikantnr.	8900203
omschrijving	thermostaat t.max. 85°C instelbereik 30-85°C 1-polig 1NO 16A voeler ø 6mm voeler L 92mm capillaire 830mm capillaire pijp geïsoleerdmm stopbus as L 23mm aspositie boven rotatiehoek 270° voelermateriaal RVS		
Toebehoren voor	375005		
	bestelnr.	110109	fabrikantnr.
	knop thermostaat t.max. 85°C ø 60mm as ø 6x4,6mm afvlakking boven zilver instelbereik 30-85°C rotatiehoek 270°		
	bestelnr.	110133	fabrikantnr.
	knop thermostaat t.max. 85°C ø 50mm as ø 6x4,6mm afvlakking boven zwart instelbereik 30-85°C rotatiehoek 270°		

bestelnr.	375694	fabrikantnr.	8900253
omschrijving	maximaalthermostaat uitschakeltemp. 255°C 3-polig 20A voeler ø 6mm voeler L 77mm capillaire 1490mm capillaire pijp geïsoleerd 1100mm stopbus voeler RVS		

bestelnr.	375694	fabrikantnr.	8900253
omschrijving	maximaalthermostaat uitschakeltemp. 255°C 3-polig 20A voeler ø 6mm voeler L 77mm capillaire 1490mm capillaire pijp geïsoleerd 1100mm stopbus voeler RVS		

maximaal thermostaten

serie 55.32_

			
bestelnr.	375694	fabrikantnr.	8900253
omschrijving	maximaalthermostaat uitschakeltemp. 255°C 3-polig 20A voeler ø 6mm voeler L 77mm capillaire 1490mm capillaire pijp geïsoleerd 1100mm stopbus voeler RVS		

bestelnr.	375694	fabrikantnr.	8900253
omschrijving	maximaalthermostaat uitschakeltemp. 255°C 3-polig 20A voeler ø 6mm voeler L 77mm capillaire 1490mm capillaire pijp geïsoleerd 1100mm stopbus voeler RVS		

toebehoren

voelerklemmen

klembeugels

voor thermostaten



1

bestelnr.	550043	fabrikantnr.	8900521 8999998
omschrijving	voelerklem voor pijp ø 17x6mm voor voeler ø 6mm vpe 1stuk		

capilaire pijp klemmen



1

bestelnr.	550004	fabrikantnr.	8900541
omschrijving	capilairklem voor pijp ø 17x6mm voor vlakke pijpverwarmer		

schakelaars en tasters

nokkenschakelaars

Aan/Uit

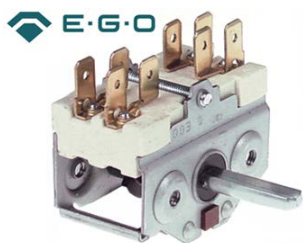

1

bestelnr.	300074	fabrikantnr.	8900301
omschrijving	nokkenschakelaar 4 schakelstanden 2NO schakelvolgorde 0-1-0-1 16A as ø 6x4,6mm as L 23mm aansluiting vlakstekker 6,3mm keramiek		





1

bestelnr.	300021	fabrikantnr.	8900302
omschrijving	nokkenschakelaar 4 schakelstanden 4NO schakelvolgorde 0-1-0-1 16A as ø 6x4,6mm as L 23mm aansluiting schroefaansluiting keramiek		

7-standen



1



bestelnr.	300025	fabrikantnr.	8900220	
omschrijving	nokkenschakelaar 7 schakelstanden 1NO/2CO schakelvolgorde 0-1-2-3-4-5-6 16A as ø 6x4,6mm as L 23mm aansluiting schroefaansluiting 7-standen keramiek			
Toebehoren voor	300025			
	bestelnr.	112172	fabrikantnr.	—
	knop universeel ø 70mm zwart zonder adapter/symbol			
	bestelnr.	112213	fabrikantnr.	—
	knopsymbol zilver schakelaar 7-standen t.max.°C OD ø 63mm ID ø 45,5mm			
	bestelnr.	112311	fabrikantnr.	—
	knop adapter as ø 6x4,6mm L 0mm met veer			

styeemschakelaars

verlichtingen



1

bestelnr.	359606	fabrikantnr.	8900425	
omschrijving	neonlamp fitting Ba9s 220V 2W transparant ø 10mm L 28mm			
Toebehoren voor	359606			
	bestelnr.	359832	fabrikantnr.	—
	lampfitting inbouwmaat ø16,2mm fitting Ba9s aansluiting vlakstekker 6,3mm			
	bestelnr.	359853	fabrikantnr.	—
	lampfitting inbouwmaat ø18,2mm fitting Ba9s aansluiting vlakstekker 6,3mm			

lampen

signaallampen

signaallampen 3-delig (behuizing, lens en gloeilamp)

ø18,2mm



1



bestelnr.	359855	fabrikantnr.	8900425
omschrijving	signaallampfitting inbouwmaat ø18,2mm fitting Ba9s groen		



1	
bestelnr.	359854 fabrikantnr. 8900426
omschrijving	signaallampfitting inbouwmaat ø18,2mm fitting Ba9s oranje

verlichtingen

neonlampen

1	
bestelnr.	359606 fabrikantnr. 8900425
omschrijving	neonlamp fitting Ba9s 220V 2W transparant ø 10mm L 28mm
Toebehoren voor	359606
	bestelnr. 359832 fabrikantnr. — lampfitting inbouwmaat ø16,2mm fitting Ba9s aansluiting vlaksteker 6,3mm
	bestelnr. 359853 fabrikantnr. — lampfitting inbouwmaat ø18,2mm fitting Ba9s aansluiting vlaksteker 6,3mm

lampen voor steek-/schroeffittingen

neonlampen

1	
bestelnr.	359606 fabrikantnr. 8900425
omschrijving	neonlamp fitting Ba9s 220V 2W transparant ø 10mm L 28mm
Toebehoren voor	359606
	bestelnr. 359832 fabrikantnr. — lampfitting inbouwmaat ø16,2mm fitting Ba9s aansluiting vlaksteker 6,3mm
	bestelnr. 359853 fabrikantnr. — lampfitting inbouwmaat ø18,2mm fitting Ba9s aansluiting vlaksteker 6,3mm

magneetschakelaars

ISKRA (FANAL)

magneetschakelaars

1	
bestelnr.	380213 fabrikantnr. 8900310
omschrijving	relais AC1 20A 230VAC (AC3/400V) 8,5A/5,5kW hoofdcontact 3NO hulpcontact 1NO aansluiting schroefaansluiting type FANAL DSL7 10 type ISKRA K07M 10

knoppen
universele knoppen

1	
bestelnr.	110116 fabrikantnr. 8900435
omschrijving	knop thermostaat t.max. 110°C ø 60mm as ø 6x4,6mm afvlakking boven zwart instelbereik 30-110°C rotatiehoek 270°

fabrikantspecifieke knoppen

ROKA	
1	
bestelnr.	110116 fabrikantnr. 8900435
omschrijving	knop thermostaat t.max. 110°C ø 60mm as ø 6x4,6mm afvlakking boven zwart instelbereik 30-110°C rotatiehoek 270°

korven
friteusekorven

ROKA	
1	
bestelnr.	970441 fabrikantnr. 8900104
omschrijving	friteusekorf L1 280mm B1 210mm H1 120mm

roosters en stelrails
oplegroosters

1	
bestelnr.	211071 fabrikantnr. 8900580
omschrijving	oplegrooster

C

capilaire pijp klemmen 6

E

elementen voor bain maries 3

elementen voor friteuses 3

elementen voor grills 4

elementen voor warmtekasten 4

H

hetelucht elementen 4

K

klembeugels 6

L

lampen 6

M

magneetschakelaars 7

maximaal thermostaten 5

N

neonlampen 7,7

nokkenschakelaars 6

R

regelthermostaten 5

roosters en stelrails 7

S

schakelaars en tasters 6

signaallampen 6

steelschakelaars 6

T

thermostaten 5

V

verwarmingselementen 3

voelklemmen 6