



GAS



ELEKTRA



WATER



MECHANIEK



GEREEDSCHAP

Reparatie-onderdelen passend voor

SOGET

Het complete assortiment vindt u altijd up-to-date in onze webshop



Fabrikant-catalogussen

Per fabrikant de belangrijkste vervangingsonderdelen en toebehoren overzichtelijk bij elkaar

- ✓ **Compleet assortiment en altijd de actuele apparatuurgegevens in de GEV-Webshop**
- ✓ **Alfabetische Index achter in de catalogus**

GEV-Webshop

www.gev-online.nl



- 🔍 **Artikel als favoriet opslaan**
- 🔍 **Inloggen met E-mailadres en bekende paswoord**
- 🔍 **Bulk bestellen - meerdere artikelen direct in de winkelwagen laden**
- 🔍 **Direct op artikel zoeken zonder je hoeven aan te melden**









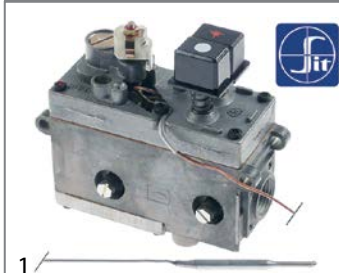





gasthermostaten

SIT

serie 710 Minisit



bestelnr.	101132	fabrikantnr.	310200
omschrijving	gasthermostaat SIT type MINISIT 710 t.max. 340°C 100-340°C gasingang 1/2" gasuitgang 3/8" thermoelementaansluiting M9x1 waakvlamaansluiting M10x1 voeler ø 5mm voeler L 68mm capillaire 1050mm sensortype type B1 drukregelaar nee drukregelaarmbar stopbus waakvlam nee		
Reparatie-onderdelen voor	101132		
	bestelnr.	101053	fabrikantnr. —
	magneetspoel Dr.G1: M9x1 Dr.G2: M24x1 L 45mm ø 17mm passend voor Minisit		
	bestelnr.	102102	fabrikantnr. —
	voeler 100-340°C voeler ø 5mm voeler L 68mm capillaire 1750mm t.max. 340°C oven/grill sensortype type B1 passend voor MINISIT 710		
Toebehoren voor	101132		
	bestelnr.	100809	fabrikantnr. —
	O-ring EPDM materiaaldikte 2mm ID ø 21mm vpe 1stuk		
	bestelnr.	100904	fabrikantnr. —
	klemschroef M10x1 voor pijpø 4mm vpe 1stuk		
	bestelnr.	100905	fabrikantnr. —
	klemschroef M10x1 voor pijpø 6mm vpe 1stuk		
	bestelnr.	101054	fabrikantnr. —
	magneetspoel Dr.G1: M10x1 Dr.G2: M24x1 L 45mm ø 17mm passend voor Minisit		
	bestelnr.	101136	fabrikantnr. —
	piëzo-ontsteker passend voor Minisit met afdekkap ømm aansluiting F6,3x0,8		
	bestelnr.	101137	fabrikantnr. —
	afdekkap zonder piëzo-ontsteker		
	bestelnr.	101267	fabrikantnr. —
	reducer BD 3/8" OD 1/2" L 21mm		
	bestelnr.	101268	fabrikantnr. —
	gasaansluiting draad 3/8" haaks met o-ring MINISIT 710		
	bestelnr.	101269	fabrikantnr. —
	gasaansluiting draad 1/2" haaks met o-ring MINISIT 710		
	bestelnr.	101270	fabrikantnr. —
	schroefconnectie BD 3/8" OD 3/8" L 28mm		
	bestelnr.	101272	fabrikantnr. —
	schroefconnectie BD 1/2" OD 3/8" L 57mm		

Toebehoren voor	101132		
	bestelnr.	101273	fabrikantnr. —
	snijring voor pijpø 12mm L 9.5mm koper vpe 1stuk passend voor universeel		
	bestelnr.	101274	fabrikantnr. —
	snijring voor pijpø 16mm vpe 1stuk		
	bestelnr.	101275	fabrikantnr. —
	knelschroef draad 1/2" voor pijpø 16mm vpe 1stuk		
	bestelnr.	101276	fabrikantnr. —
	knelschroef draad 3/8" pijp ø 12mm vpe 1stuk		
	bestelnr.	110068	fabrikantnr. —
	knop passend voor Minisit ø 37mm		

ontstekingstechniek

waakvlambranders

SIT

serie 100

toebehoren

ontstekingselektroden



bestelnr.	100707	fabrikantnr.	300903
omschrijving	bougie D1 ø 7mm D2 ø 9mm aansluiting ø2,4mm L1 14mm L2 6mm LL1 18mm LL2 3mm LL3 23mm voor het klemmen vpe 1stuk		

elektroden

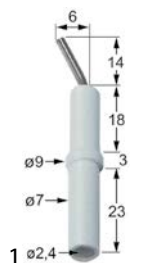

bestelnr.	100707	fabrikantnr.	300903
omschrijving	bougie D1 ø 7mm D2 ø 9mm aansluiting ø2,4mm L1 14mm L2 6mm LL1 18mm LL2 3mm LL3 23mm voor het klemmen vpe 1stuk		

1 gas componenten

piëzo-ontstekers

inbouwdiameter 22mm

			
1			
bestelnr.	100013	fabrikantnr.	300900
omschrijving	piëzo-ontsteker behuizing kunststof drukkend inbouw ø 22mm aansluiting ø2,4mm kabellengtemm		
Toebehoren voor	100013		
	bestelnr.	100023	fabrikantnr. —
rondstekerhuls grootte 2.3mm 0,5-1,5mm ² CuZn t.max. 125°C vpe 20stuk			

thermokoppels

insteekthermokoppels

insteekthermokoppels standaard

met steekhuls ø6(6,5)mm

thermokoppels SIT

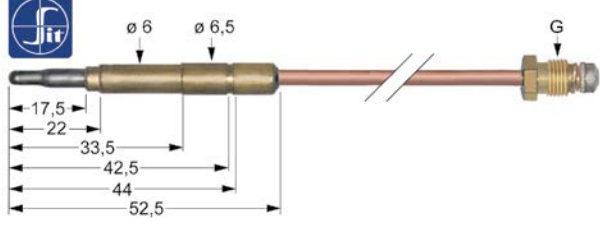
			
1			
bestelnr.	107613	fabrikantnr.	310403 410403
omschrijving	thermokoppel SIT M9x1 L 1200mm steekhuls ø6,0(6,5)mm		

G

gasthermostaten 3

P

piëzo-ontstekers 4

T

thermokoppels 4

W

waakvlambranders 3