



GAS



ELEKTRA



WATER



MECHANIEK



GEREEDSCHAP

Reparatie-onderdelen passend voor

STAHL

Het complete assortiment vindt u altijd up-to-date in onze webshop



Fabrikant-catalogussen

Per fabrikant de belangrijkste vervangingsonderdelen en toebehoren overzichtelijk bij elkaar

- ✓ **Compleet assortiment en altijd de actuele apparatuurgegevens in de GEV-Webshop**
- ✓ **Alfabetische Index achter in de catalogus**

GEV-Webshop

www.gev-online.nl



- 🔍 **Artikel als favoriet opslaan**
- 🔍 **Inloggen met E-mailadres en bekende paswoord**
- 🔍 **Bulk bestellen - meerdere artikelen direct in de winkelwagen laden**
- 🔍 **Direct op artikel zoeken zonder je hoeven aan te melden**



verwarmingselementen

elementen voor bain maries

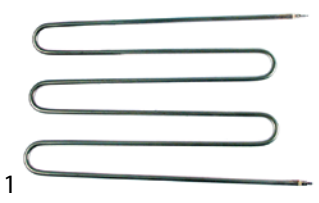

1

bestelnr.	418280	fabrikantnr.	160031
omschrijving	verwarmingselement 1200W 230V VC 1 L 410mm B 233mm aansluiting M4 aansluitafstand 225mm pijp ø 8.5mm droog verwarmingselement Bain-Marie		

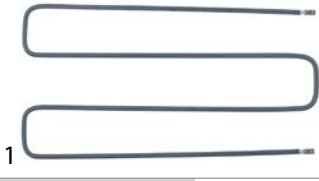







1

bestelnr.	415545	fabrikantnr.	160025
omschrijving	verwarmingselement 855W 240V VC 1 L 380mm L1 410mm B 204mm aansluiting vlaksteker 6,3mm aansluitafstand 196mm pijp ø 6.5mm droog verwarmingselement		

verwarmingsbodems



1

bestelnr.	415661	fabrikantnr.	160087	
omschrijving	element onderbouw 3000W 230V VC 2 ø 196mm maximaal thermostaat 250°C thermostaat 128°C M5 bevestigingsafstand 180mm			
Reparatie-onderdelen voor	415661			
	bestelnr.	102067	fabrikantnr.	—
	moer draad M8x1 H 3mm koper vpe 1stuk type SEF 1			
	bestelnr.	375137	fabrikantnr.	—
	maximaalthermostaat uitschakeltemp. 250°C 1-polig 16A voeler ø 3.03mm voeler L 160mm capillaire 880mm capillaire pijp geïsoleerd 800mm stopbus voeler RVS met gebogen voeler			
	bestelnr.	375300	fabrikantnr.	—
	thermostaat t.max. 128°C instelbereik 35-128°C 1-polig 1NO 16A voeler ø 3.1mm voeler L 174mm capillaire 880mm capillaire pijp geïsoleerd 800mm stopbus as L 23mm aspositie onder rotatiehoek 270°			
Toebehoren voor	415661			
	bestelnr.	520323	fabrikantnr.	—
	pakking ID ø 160mm OD ø 200mm LA 90/180mm gat ø 7mm silicone voor verwarmingsbodem			
	bestelnr.	520324	fabrikantnr.	—
	tegenflens ID ø 160mm OD ø 200mm LA 90/180mm gat ø 7mm RVS voor verwarmingsbodem			
	bestelnr.	551083	fabrikantnr.	—
	kap voor maximaal thermostaat draad M8x1			

verwarmingsplaten

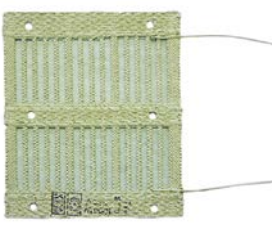

1



bestelnr.	415734	fabrikantnr.	160055
omschrijving	warmtenet 1000W 230V voor warmtecast VC 1 L 220mm B 260mm		

keramiekstralers

245 x 60mm





1

bestelnr.	415101	fabrikantnr.	160065	
omschrijving	keramiekstraler 250W 230V kabel kralenstreng L 245mm B 60mm H 35mm			
Reparatie-onderdelen voor	415101			
	bestelnr.	415109	fabrikantnr.	—
	klemveer			
Toebehoren voor	415101			
	bestelnr.	415110	fabrikantnr.	—
	reflector L 245mm B 95mm H 31mm materiaaldikte 0.75mm gat ø 15x40mm			



1

bestelnr.	415102	fabrikantnr.	160070	
omschrijving	keramiekstraler 400W 230V kabel kralenstreng L 245mm B 60mm H 35mm			
Reparatie-onderdelen voor	415102			
	bestelnr.	415109	fabrikantnr.	—
	klemveer			
Toebehoren voor	415102			
	bestelnr.	415110	fabrikantnr.	—
	reflector L 245mm B 95mm H 31mm materiaaldikte 0.75mm gat ø 15x40mm			

toebehoren



1

bestelnr.	550871	fabrikantnr.	160095
omschrijving	isolator vrouwelijk H 6mm gat ø 9.2mm ø 15mm		

energieregelaars

EGO

1-kring



1

bestelnr.	380015	fabrikantnr.	167115
omschrijving	energieregelaar 230V 13A enkel circuit draairichting rechts as ø 6x4,6mm as L 23mm bevestigingsdraad M4 vermogensafgave 6-100% nr. 50.57021.010		

thermostaten

regel- en maximaalthermostaten

EGO

regelthermostaten

serie 55.34_



1

bestelnr.	375143	fabrikantnr.	162020
omschrijving	thermostaat t.max. 110°C instelbereik 32-110°C 3-polig 3NO 16A voeler ø 6mm voeler L 138mm capillaire 1480mm capillaire pijp geïsoleerd 1100mm stopbus M9x1 as ø 6x4,6mm as L 23mm aspositie boven rotatiehoek 270°		

E-G-O



1

bestelnr.	375019	fabrikantnr.	162015
omschrijving	thermostaat t.max. 85°C instelbereik 30-85°C 3-polig 3NO 16A voeler ø 6mm voeler L 131mm capillaire 1440mm capillaire pijp geïsoleerdmm stopbus M9x1 as ø 6x4,6mm as L 23mm aspositie boven rotatiehoek 270°		

regelthermostaten met voorzetschakelaar

serie 55.34_

E-G-O



1

bestelnr.	375876	fabrikantnr.	162015
omschrijving	thermostaat t.max. 85°C instelbereik 30-85°C 3-polig 3NO 16A voeler ø 6mm voeler L 131mm capillaire 1440mm capillaire pijp geïsoleerdmm stopbus M9x1 as ø 6x4,6mm as L 23mm aspositie boven aspositie° rotatiehoek 270° voorzetschakelaar 2NO met voorzetschakelaar		

schakelaars en tasters

nokkenschakelaars

Aan/Uit



1

bestelnr.	300020	fabrikantnr.	167100 A67100	
omschrijving	nokkenschakelaar 4 schakelstanden 2NO schakelvolgorde 0-1-0-1 16A as ø 6x4,6mm as L 23mm aansluiting schroefaansluiting keramiek			
Toebehoren voor	300020			
	bestelnr.	110135	fabrikantnr.	—
	rozet knop tot ø 52mm			
	bestelnr.	110231	fabrikantnr.	—
	knop schakelaar 0-1-0-1 t.max. °C ø 50mm as ø 6x4,6mm afvlakking boven zwart			

7-standen



bestelnr.	301233	fabrikantnr.	Nockenschalter 7-Tak
omschrijving	nokkenschakelaar 7-standen		

4-schakelstanden

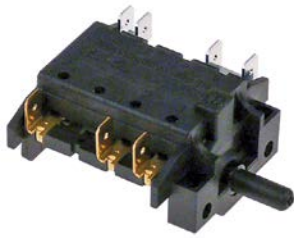

bestelnr.	301199	fabrikantnr.	167105
omschrijving	nokkenschakelaar 4 schakelstanden 3NO schakelvolgorde 0-1-2-3 16A as ø 6x4,6mm as L 15mm aansluiting vlakstecker 6,3mm		

lampen

signaallampen

signaallampen compleet

ø14mm

met steekfitting



bestelnr.	359677	fabrikantnr.	168080
omschrijving	signaallamp ø 14mm geel 230V aansluiting F2,8/F6,3		

staaflampen

infraroodlampen

met fittingtype R7s



bestelnr.	359676	fabrikantnr.	160063 161030
omschrijving	infraroodlamp fitting R7s L 190mm 230V 350W IMPORT t.max. 500°C		

fittingen voor staaflampen

R7s



bestelnr.	359717	fabrikantnr.	160063
omschrijving	lampfitting fitting R7s 250V ø 18mm Lmm H 31mm aansluiting kabel 320mm bevestigingsafstand 28mm houderlengte 37mm kabelmateriaal PTFE		

ventilatoren

heteluchtventilatoren

ebm-papst

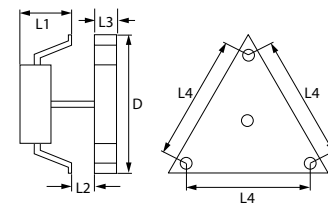

bestelnr.	601249	fabrikantnr.	161030
omschrijving	heteluchtventilator 230V 32W 0.27A L1 60mm L2 20mm L3 20mm L4 157mm ventilatorblad ø 150mm ebm-papst type R2K150-AC01-15		

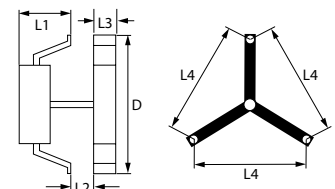

bestelnr.	601013	fabrikantnr.	161.030
omschrijving	heteluchtventilator 230V 43W 0.25A L1 60mm L2 20mm L3 25mm L4 155mm ventilatorblad ø 150mm type R2S150-AA08-29 ebm-papst 2200U/min		

ladegeleiders

telescoop-ladegeleiders

fabrikantspecifiek



bestelnr.	692732	fabrikantnr.	1120.052
omschrijving	teleskooprailset L 550mm uittrek lengte 590mm totale lengte 1140mm VPE 1 paar draagcapaciteit 50kg B 15mm H 60mm inbouwpositie rechts/links RVS telescopisch		

1			
bestelnr.	691636	fabrikantnr.	120.056 FR 6010 580lg
omschrijving	teleskooprailset L 580mm uittrek lengte 620mm VPE 1 paar draagcapaciteit 50kg B 15mm H 60mm inbouwpositie rechts/links RVS telescopisch L1 35mm L2 548mm		

E

elementen voor bain maries	3
energieregelaars	4

H

heteluchtventilatoren	5
-----------------------	---

I

infraroodlampen	5
-----------------	---

K

keramiekstralers	3
------------------	---

L

lampen	5
--------	---

N

nokkenschakelaars	4
-------------------	---

R

regelthermostaten	4
-------------------	---

S

schakelaars en tasters	4
signaallampen	5
signaallampen compleet	5
staaflampen	5

T

thermostaten	4
--------------	---

V

ventilatoren	5
verwarmingsbodems	3
verwarmingselementen	3
verwarmingsplaten	3