



GAS



ELEKTRA



WATER



MECHANIEK



GEREEDSCHAP

Reparatie-onderdelen passend voor

VEGA

Het complete assortiment vindt u altijd up-to-date in onze webshop



Fabrikant-catalogussen

Per fabrikant de belangrijkste vervangingsonderdelen en toebehoren overzichtelijk bij elkaar

- ✓ **Compleet assortiment en altijd de actuele apparatuurgegevens in de GEV-Webshop**
- ✓ **Alfabetische Index achter in de catalogus**

GEV-Webshop

www.gev-online.nl



- 🔍 **Artikel als favoriet opslaan**
- 🔍 **Inloggen met E-mailadres en bekende paswoord**
- 🔍 **Bulk bestellen - meerdere artikelen direct in de winkelwagen laden**
- 🔍 **Direct op artikel zoeken zonder je hoeven aan te melden**

verwarmingselementen

elementen voor bain maries

			
bestelnr.	416161	fabrikantnr.	92023
omschrijving	verwarmingselement 1000W 230V VC 1 L 430mm B 95mm aansluiting vlaksteker 6,3mm aansluitafstand 40mm aansluitingslengte 10mm pijp ø 6.3mm droog verwarmingselement B2 39mm H 36mm		
Voor modellen:	BM1		





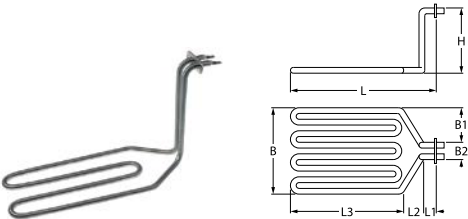

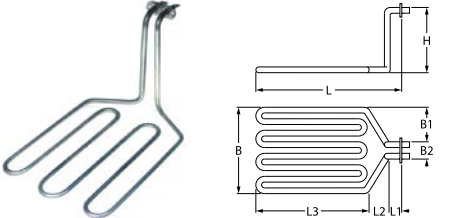

			
bestelnr.	418502	fabrikantnr.	92028 92028G
omschrijving	verwarmingselement 1200W 230V VC 1 L 410mm B 195mm aansluiting vlaksteker 6,3mm pijp ø 6.5mm droog verwarmingselement		

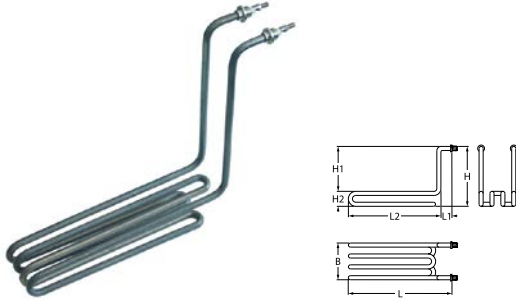
elementen voor friteuses

			
bestelnr.	418531	fabrikantnr.	N/A
omschrijving	verwarmingselement 2000W 230V VC 1 L 296mm B 120mm H 170mm rechthoekige flens aansluiting vlaksteker 6,3mm dompel verwarmingselement L1 14mm L2 70mm L3 212mm B1 50mm B2 27mm LA 40mm windingen 2 gat ø 4mm flens L 51mm flens B 22mm pijp ø 8.5mm aansluitingslengte 37mm		

			
bestelnr.	418501	fabrikantnr.	93178
omschrijving	verwarmingselement 3000W 230V VC 1 L 280mm B 191mm H 164mm rechthoekige flens aansluiting vlaksteker 6,3mm L1 15mm L2 35mm L3 230mm B1 80mm B2 31mm LA 40mm windingen 3 gat ø 4mm flens L 50mm flens B 22mm		

tweegatsbevestiging

			
bestelnr.	416172	fabrikantnr.	93097
omschrijving	verwarmingselement 3000W 230V VC 1 L 300mm B 80mm H 255mm L1 43mm L2 257mm H1 215mm H2 40mm draad 1/4" bevestigingsafstand 67mm pijp ø 8.5mm 2-gatsbevestiging aansluiting M5 aansluitingslengte 12mm dompel verwarmingselement windingen 4		
Reparatie-onderdelen voor	416172		
	bestelnr.	510417	fabrikantnr. —
	vlakpakking fiber OD ø 20mm ID ø 14mm materiaaldikte 2mm vpe 1stuk		
	bestelnr.	528723	fabrikantnr. —
	vlakpakking FIBER OD ø 20mm ID ø 13mm materiaaldikte 1mm vpe 1stuk		
Toehoren voor	416172		
	bestelnr.	361182	fabrikantnr. —
	moer draad 1/4" H 5mm MsNi SB 17 vpe 1stuk		
	bestelnr.	520228	fabrikantnr. —
	tandring ID ø 15.3mm OD ø 24mm staal vpe 1stuk voor draad M14		
	bestelnr.	550262	fabrikantnr. —
	vlakpakking koper OD ø 20mm ID ø 14mm materiaaldikte 2mm		
	bestelnr.	560112	fabrikantnr. —
	onderlegging ID ø 5.3mm OD ø 10mm materiaaldikte 1mm RVS vpe 20stuk DIN 125A voor draad M5		
	bestelnr.	560132	fabrikantnr. —
	zeskantmoer draad M5 H 4mm SB 8 RVS DIN/ISO DIN 934 / ISO 4032/8673 vpe 20stuk		

elementen voor grillplaten

			
bestelnr.	416161	fabrikantnr.	92023
omschrijving	verwarmingselement 1000W 230V VC 1 L 430mm B 95mm aansluiting vlaksteker 6,3mm aansluitafstand 40mm aansluitingslengte 10mm pijp ø 6.3mm droog verwarmingselement B2 39mm H 36mm		
Voor modellen:	BM1		



elementen voor contactgrills





1

bestelnr.	417662	fabrikantnr.	Heizung zu 80879
omschrijving	verwarmingselement 2400W 230V VC 1 L 315mm B 285mm H 50mm aansluitafstand 280mm pijp ø 8.5mm		

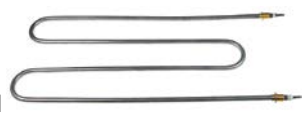
elementen voor pizzaovens



1

bestelnr.	416848	fabrikantnr.	93107
omschrijving	verwarmingselement 800W 230V L 445mm B 195mm draad 1/4" bevestigingsafstand 186mm aansluitingslengte 15mm aansluiting M4 pijp ø 8.5mm VC 1 droog verwarmingselement 2-gatsbevestiging		
Toebehoren voor	416848		
	bestelnr.	361182	fabrikantnr. —
	moer draad 1/4" H 5mm MsNi SB 17 vpe 1stuk		
	bestelnr.	510417	fabrikantnr. —
	vlakpakking fiber OD ø 20mm ID ø 14mm materiaaldikte 2mm vpe 1stuk		
	bestelnr.	520228	fabrikantnr. —
	tandring ID ø 15.3mm OD ø 24mm staal vpe 1stuk voor draad M14		
	bestelnr.	550262	fabrikantnr. —
	vlakpakking koper OD ø 20mm ID ø 14mm materiaaldikte 2mm		

elementen voor kookplaten

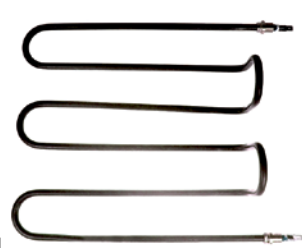

1

bestelnr.	418518	fabrikantnr.	für 81133V1
omschrijving	verwarmingselement 1300W 230V		



1

bestelnr.	418516	fabrikantnr.	für 81132
omschrijving	verwarmingselement 650W 230V		

elementen voor warmtekasten

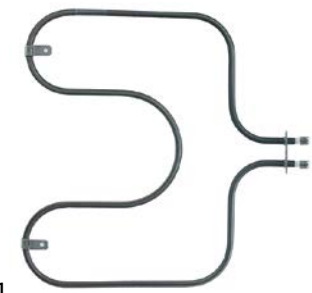

1

bestelnr.	416719	fabrikantnr.	93272
omschrijving	verwarmingselement 600W 230V VC 1 L 259mm B 275mm flens L 44mm flens B 22mm aansluiting vlaksteker 6,3mm pijp ø 6.5mm rechthoekige flens gat ø 4mm droog verwarmingselement L1 45mm L2 214mm B1 125mm B2 29mm		

kwartselementen



1

bestelnr.	416020	fabrikantnr.	92000
omschrijving	kwartsbuis WV L 390mm ID ø 9mm OD ø 11mm		



1

bestelnr.	419179	fabrikantnr.	93119 93119G
omschrijving	kwartselement 700W 110V L 560mm ø 11.5mm aansluiting F6,3 17.5Ohm		



1

bestelnr.	415303	fabrikantnr.	92027
omschrijving	verwarmingselement 400W 115V L 340mm ø 12mm aansluiting vlaksteker 6,3mm		
Voor modellen:	T2		

energieregelaars

EGO

1-kring



1

bestelnr.	380015	fabrikantnr.	93087G
omschrijving	energieregelaar 230V 13A enkel circuit draairichting rechts as \varnothing 6x4,6mm as L 23mm bevestigingsdraad M4 vermogensafgave 6-100% nr. 50.57021.010		

thermostaten

regel- en maximaalthermostaten

EGO

regelthermostaten

serie 55.10/19_



1

bestelnr.	375856	fabrikantnr.	93238
omschrijving	thermostaat t.max. 187°C instelbereik 101-187°C 1-polig 1NO 16A voeler \varnothing 6mm voeler L 130mm capillaire 900mm capillaire pijp geïsoleerd 700mm stopbus M10x1 as \varnothing 6x4,6mm as L 23mm aspositie boven rotatiehoek 270°		

Serie 55.13_



1

bestelnr.	375530	fabrikantnr.	93044 G
omschrijving	thermostaat t.max. 400°C instelbereik 100-400°C 1-polig 1NO 16A voeler \varnothing 3.9mm voeler L 163mm capillaire 830mm capillaire pijp geïsoleerdmm stopbus as \varnothing 6x4,6mm as L 23mm aspositie boven rotatiehoek 270°		

maximaal thermostaten

serie 55.10/19_



1

bestelnr.	375339	fabrikantnr.	93239G	
omschrijving	maximaalthermostaat uitschakeltemp. 225°C 1-polig 0.5A voeler \varnothing 6mm voeler L 133mm capillaire 870mm capillaire pijp geïsoleerdmm stopbus M10x1 voeler			
Toebehoren voor	375339			
	bestelnr.	551083	fabrikantnr.	—
	kap voor maximaal thermostaat draad M8x1			

IMIT / TEMPOMATIC / ARHERMO

regelthermostaten



1

bestelnr.	375805	fabrikantnr.	93001
omschrijving	thermostaat t.max. 90°C instelbereik 0-90°C 1-polig 1CO 15A voeler \varnothing 6.5mm voeler L 85mm capillaire 1000mm capillaire pijp geïsoleerd 900mm stopbus as \varnothing 6x4,6mm as L 19mm rotatiehoek 270°		

TECASA

regelthermostaten



1

bestelnr.	375801	fabrikantnr.	93179
omschrijving	thermostaat t.max. 180°C instelbereik 50-180°C 1-polig 1NO 16A voeler \varnothing 6mm voeler L 75mm capillaire 420mm capillaire pijp geïsoleerdmm stopbus as \varnothing 6x4,6mm rotatiehoek 270°		
Voor modellen:	81064, 81065, CHEF		



maximaal thermostaten



bestelnr.	390028	fabrikantnr.	93037
omschrijving	maximaalthermostaat uitschakeltemp. 230°C 1-polig 16A voeler ø 3mm voeler L 155mm capillaire 890mm capillaire pijp geïsoleerd 600mm stopbus voeler RVS		



bestelnr.	375195	fabrikantnr.	93180
omschrijving	maximaalthermostaat uitschakeltemp. 240°C 1-polig 16A voeler ø 4mm voeler L 84mm capillaire 400mm capillaire pijp geïsoleerd 130mm stopbus voeler RVS		
Voor modellen:	81064, 81065, CHEF		

schakelaars en tasters

wipschakelaar/drukschakelaars

30x11mm



bestelnr.	301010	fabrikantnr.	93258
omschrijving	wipschakelaar inbouwmaat 30x11mm rood 1NO/signaallamp 250V 16A 0-I aansluiting vlaksteker 6,3mm omgevingstemperatuur max. 85/125°C bescherming IP40		

Toebehoren voor	301010		
	bestelnr.	301035	fabrikantnr. —
	beschermkap inbouwmaat 30x11mm		

30x22mm



bestelnr.	345641	fabrikantnr.	93002
omschrijving	wipschakelaar inbouwmaat 30x22mm rood 2NO 230V 16A verlicht 0-I aansluiting vlaksteker 6,3mm omgevingstemperatuur max. 125/55°C bescherming IP65 met rubber kraag		

microschakelaars

hendelbediening



bestelnr.	346969	fabrikantnr.	Microschalter zu 81207
omschrijving	microschakelaar met hendel 250V 16A 1NO aansluiting vlaksteker 6,3mm L 59mm L1 29mm omgevingstemperatuur max. 120°C bevestigingsafstand 22mm besturingskracht: 50g hendellengte 50mm		

lampen

signaallampen

signaallampen compleet

ø12mm

met steekfitting



bestelnr.	359898	fabrikantnr.	für 81141V1
omschrijving	signaallamp ø 12mm 230V groen aansluiting vlaksteker 6,3mm		

ø13mm

met steekfitting



bestelnr.	359143	fabrikantnr.	93004
omschrijving	signaallamp ø 13mm geel 230V aansluiting vlaksteker 6,3mm temp. bestendigheid 120°C vpe 1stuk		
Voor modellen:	81064, 81065, T2		



timers

mechanische timers



1

bestelnr.	350044	fabrikantnr.	93003
omschrijving	tijdschakelaar C20 2-polig looptijd 15min aandrijving mechanisch 2NO bij 250V 16A vaste positie nee as ø 6x4,6mm as 6x4,6mm as L 20mm bevestigingsafstand 28mm aansluiting zijdelings voor rooster		
Voor modellen:	T2		
Toebehoren voor	350044		
	bestelnr.	110285	fabrikantnr. —
	knop schakelaar nulstreep t.max.°C ø 40mm as ø 6x4,6mm afvlakking boven zwart		

apparaatspecifieke bouwdeelen

voor kookplaten

warmhoudplaten

onderdelen



1

bestelnr.	693839	fabrikantnr.	93234
omschrijving	warmhoudplaat maat 270x150x10(6)mm		

knoppen

universele knoppen



1

bestelnr.	112121	fabrikantnr.	93314
omschrijving	knop thermostaat t.max. 180°C ø 48mm as ø 6x4,6mm afvlakking boven instelbereik 70-180°C rotatiehoek 270°		

fabrikantspecifieke knoppen

VEGA



1

bestelnr.	112120	fabrikantnr.	93052
omschrijving	knop schakelaar nulstreep ø 40mm		



1

bestelnr.	110650	fabrikantnr.	93052
omschrijving	knop schakelaar nulstreep ø 40mm as ø 6x4,6mm afvlakking onder zwart		



1

bestelnr.	110657	fabrikantnr.	93052
omschrijving	knop schakelaar nulstreep t.max.°C instelbereik°C ø 40mm as ø 6x4,6mm afvlakking onder zwart		



1

bestelnr.	112121	fabrikantnr.	93314
omschrijving	knop thermostaat t.max. 180°C ø 48mm as ø 6x4,6mm afvlakking boven instelbereik 70-180°C rotatiehoek 270°		

grootkeukenkranen

afvoerkranen

universeel

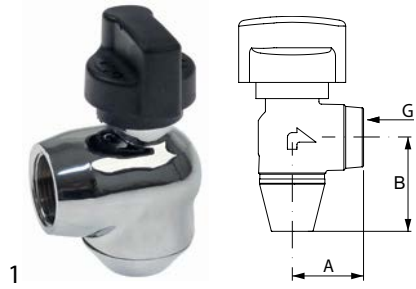

bestelnr.	540699	fabrikantnr.	93038
omschrijving	uitloopkraan B 35mm H 35mm draad 3/4" ID		

E

elementen voor bain maries	3
elementen voor contactgrills	4
elementen voor friteuses	3
elementen voor grillplaten	3
elementen voor kookplaten	4
elementen voor pizzaovens	4
elementen voor warmtekasten	4
energieregelaars	5

K

kwartselementen	4
-----------------	---

L

lampen	6
--------	---

M

maximaal thermostaten	5
mechanische timers	7
microschakelaars	6

R

regelthermostaten	5,5
-------------------	-----

S

schakelaars en tasters	6
signaallampen	6
signaallampen compleet	6

T

thermostaten	5
timers	7

V

verwarmingselementen	3
----------------------	---

W

wipschakelaar/drukschakelaars	6
-------------------------------	---