



GAS



ELEKTRA



WATER



MECHANIEK



GEREEDSCHAP

Reparatie-onderdelen passend voor

VULCAN

Het complete assortiment vindt u altijd up-to-date in onze webshop



Fabrikant-catalogussen

Per fabrikant de belangrijkste vervangingsonderdelen en toebehoren overzichtelijk bij elkaar

- ✓ **Compleet assortiment en altijd de actuele apparatuurgegevens in de GEV-Webshop**
- ✓ **Alfabetische Index achter in de catalogus**

GEV-Webshop

www.gev-online.nl



- 🔍 **Artikel als favoriet opslaan**
- 🔍 **Inloggen met E-mailadres en bekende paswoord**
- 🔍 **Bulk bestellen - meerdere artikelen direct in de winkelwagen laden**
- 🔍 **Direct op artikel zoeken zonder je hoeven aan te melden**



schakelaars en tasters

wipschakelaar/drukschakelaars

37x21mm



1

bestelnr.	348098 ¹	fabrikantnr.	00-358628-00001 358628-00001 358628-1
omschrijving	wipschakelaar inbouwmaat 37x21mm zwart 2CO 250V 10A met middelste positie aansluiting vlaksteker 6,3mm omgevingstemperatuur max. 125/55°C bescherming IP55		

¹met neutrale positie

lampen

signaallampen

signaallampen compleet

ø12mm

met steekfitting



1

bestelnr.	580014	fabrikantnr.	843808 844367-7
omschrijving	signaallamp ø 12mm 230V rood		

magneetschakelaars

HARTLAND

magneetschakelaars

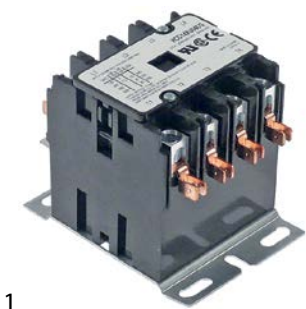

1

bestelnr.	580012	fabrikantnr.	111497D3 411497D3 844329 853270
omschrijving	relais AC1 50A 240VAC 40A/10HP (AC3/240V) 40A/7,46kW hoofdcontact 4NO aansluiting schroefklem/vlaksteker 6,3mm type HCCY4XU04CG		

gasventielen en branderautomaten

gasregelventielen

ROBERTSHAW

elektrisch gestuurde gasventielen



1



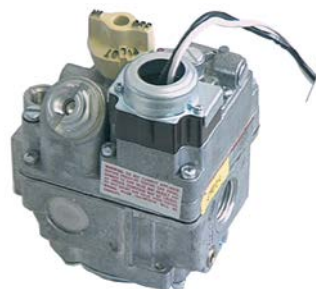

bestelnr.	101429	fabrikantnr.	470841-3
omschrijving	gasventiel 120V 50/60Hz gasingang 3/4" gasuitgang 3/4" thermo-elementaansluiting 3/8" NEF waakvlamaansluiting 1/4" pijp amerikaans type 7000BMSER-120 drukregelaar aardgas 3,5" W.C. passend voor ROBERTSHAW		
Reparatie-onderdelen voor	101429		
	bestelnr.	101047	fabrikantnr. —
	magneetspoel Dr.G1: ASA 11/32 Dr.G2: M24x1 L 59mm ø 4mm passend voor ROBERTSHAW		
	bestelnr.	101389	fabrikantnr. —
	drukregelaar aardgas passend voor ROBERTSHAW		
	bestelnr.	580033	fabrikantnr. —
	knop passend voor ROBERTSHAW		
Toebehoren voor	101429		
	bestelnr.	580035	fabrikantnr. 110839-1 410839-1
	thermogenerator L 36" - 915mm voeler ø 9mm voeler L 38mm 250-750mV schroefaansluiting 7/16" aansluiting 3/8" NEF		



1

bestelnr.	580044	fabrikantnr.	110841-3 410841-00003 410841-3
omschrijving	gasventiel voeding 120VAC 50/60Hz gasingang 3/4" NPT gasuitgang 3/4" NPT thermo-elementaansluiting 11/32" waakvlamaansluiting 1/4" CCT type 7000BER-120 drukregelaar aardgas 3,5" W.C. passend voor ROBERTSHAW		
Reparatie-onderdelen voor	580044		
	bestelnr.	101047	fabrikantnr. —
	magneetspoel Dr.G1: ASA 11/32 Dr.G2: M24x1 L 59mm ø 4mm passend voor ROBERTSHAW		

Tabel wordt vervolgd op de volgende pagina

Reparatie-onderdelen voor 580044			
	bestelnr.	101389	fabrikantnr.
			—
	drukregelaar aardgas passend voor ROBERTSHAW		
	bestelnr.	106109	fabrikantnr.
			—
	klemschroef draad 7/16"-24 UNS voor pijp 1/4" L 16mm koper vpe 1stuk SB 7/16" (11,113mm) gat ø 6.4mm		
	bestelnr.	580033	fabrikantnr.
			—
	knop passend voor ROBERTSHAW		
Toebehoren voor 580044			
	bestelnr.	102122	fabrikantnr.
			—
	thermokoppel ROBERTSHAW ASA 11/32 L 18" - 455mm 7/16"		
	bestelnr.	102277	fabrikantnr.
			—
	thermokoppel ROBERTSHAW ASA 11/32 L 36" - 915mm 7/16"		

gasgestuurde gasventielen			
			
	1		
bestelnr.	580043	fabrikantnr.	110841-1 410841-1
omschrijving	gasventiel voedingsoperator gas ingang 1/4" CCT uitgang 1/4" CCT gasingang 3/4" NPT gasuitgang 3/4" NPT thermoelementaansluiting 3/8" NEF waakvlamaansluiting 1/4" CCT type 7000BMSGOR drukregelaar aardgas 3,5" W.C. passend voor ROBERTSHAW		
Reparatie-onderdelen voor 580043			
	bestelnr.	101042	fabrikantnr.
			—
	magneetspoel Dr.G1: 3/8" NEF passend voor ROBERTSHAW voor gas-operator		
	bestelnr.	101481	fabrikantnr.
			—
	snijring voor pijp 1/4" CCT vpe 1stuk		
	bestelnr.	106109	fabrikantnr.
			—
	klemschroef draad 7/16"-24 UNS voor pijp 1/4" L 16mm koper vpe 1stuk SB 7/16" (11,113mm) gat ø 6.4mm		
	bestelnr.	580033	fabrikantnr.
			—
	knop passend voor ROBERTSHAW		
Toebehoren voor 580043			
	bestelnr.	580035	fabrikantnr.
			110839-1 410839-1
	thermogenerator L 36" - 915mm voeler ø 9mm voeler L 38mm 250-750mV schroefaansluiting 7/16" aansluiting 3/8" NEF		

ontstekingstechniek

waakvlambranders

ROBERTSHAW

waakvlambranders

universele serie - type 2









1



bestelnr.	107402	fabrikantnr.	109839-1 109839-3 409839-1 409839-3 409839-3 (LP) / 409839-1 (NAT)
omschrijving	waakvlambrander ROBERTSHAW type 2C-2 1-vlammig aardgas/flessengas identificatienummer 18/10 voor pijp 1/4" CCT		





1

bestelnr.	100117	fabrikantnr.	112787-1 412787-1 412787-1 (NAT)
omschrijving	waakvlambrander ROBERTSHAW type 2CH-1 1-vlammig aardgas identificatienummer 18 voor pijp 1/4" CCT		
Toebehoren voor 100117			
	bestelnr.	100275	fabrikantnr.
			109839-6
	waakvlaminspuiters flessengas identificatienummer 10 boring ø 0.1mm passend voor ROBERTSHAW		
	bestelnr.	100276	fabrikantnr.
			—
	waakvlaminspuiters aardgas identificatienummer 18 passend voor ROBERTSHAW		
	bestelnr.	100277	fabrikantnr.
			—
	waakvlaminspuiters aardgas identificatienummer 26 passend voor ROBERTSHAW		
	bestelnr.	101286	fabrikantnr.
			—
	snijring ID ø 6mm vpe 1stuk		
	bestelnr.	101481	fabrikantnr.
			—
	snijring voor pijp 1/4" CCT vpe 1stuk		
	bestelnr.	101483	fabrikantnr.
			—
	overzetmoer draad 1/4" CCT kort		





universele serie - type 3			
			
1			
bestelnr.	107398	fabrikantnr.	112082-1 112082-2 412082-1 412082-1 (NAT) / 412082-2 (LP)
omschrijving	waakvlambrander ROBERTSHAW type 3CH-10 2-vlammig aardgas/flessengas identificatienummer 16/10 voor pijpø 1/4" CCT		
Reparatie-onderdelen voor	107398		
	bestelnr.	fabrikantnr.	109839-6
	waakvlaminspuiters flessengas identificatienummer 10 boring ø 0.1mm passend voor ROBERTSHAW		
	bestelnr.	fabrikantnr.	—
	waakvlaminspuiters flessengas identificatienummer 16 passend voor ROBERTSHAW		

serie 11EA			
			
1			
bestelnr.	107412	fabrikantnr.	00-409125-00001 00-409125-00003 109125-1 109125-3 409125-1 409125-3 729125-1 729125-3
omschrijving	waakvlambrander ROBERTSHAW type 11EA 1-vlammig aardgas voor pijpø 3/16" & 1/4" CCT		

universele serie - type 6			
<p><i>Breedte specificatie voor bovendelen:</i> 6CH10 = 1" (25,4mm) 6CH14 = 1½" (38,1mm) 6CH24 = 2½" (63,5mm) 6CH30 = 3" (76,2mm)</p>			
			
1			
bestelnr.	106346	fabrikantnr.	112212-1 412212-1
omschrijving	waakvlambrander ROBERTSHAW type 6CH14-10 3-vlammig aardgas identificatienummer 22 voor pijpø 1/4" CCT gasaansluiting 1/4" CCTmm		

serie Mini Pilot			
			
1			
bestelnr.	107414	fabrikantnr.	2693 802693
omschrijving	waakvlambrander ROBERTSHAW type 2 2-vlammig aardgas/flessengas identificatienummer voor pijpø 3/16" & 1/4" CCT met thermokoppel		

			
1			
bestelnr.	107396	fabrikantnr.	805925-11 F5925-11
omschrijving	waakvlambrander ROBERTSHAW type 6CH24-6 3-vlammig aardgas/flessengas identificatienummer 16/26 voor pijpø 1/4" CCT		
Reparatie-onderdelen voor	107396		
	bestelnr.	fabrikantnr.	—
	waakvlaminspuiters aardgas identificatienummer 26 passend voor ROBERTSHAW		
	bestelnr.	fabrikantnr.	—
	waakvlaminspuiters flessengas identificatienummer 16 passend voor ROBERTSHAW		

fabrikantspecifieke waakvlambranders			
VULCAN HART			
			
1			
bestelnr.	107391	fabrikantnr.	00-410662-000G1 110662G1 112071G1 112073G1 113866G1 410662G1 412071G1 412073G1 421573G4
omschrijving	waakvlambrander 4-vlammig 3/16"		



1

bestelnr.	107413	fabrikantnr.	00-414645-0001 114645-1 414645-1
omschrijving	waakvlambrander type 43U4		

thermokoppels

universele thermokoppels (sets)



1

bestelnr.	102281	fabrikantnr.	00-412788-0001 112788-1 20040 412788-1 920040
omschrijving	thermokoppelsset ROBERTSHAW 5-delig L 24" - 610mm		



1

bestelnr.	103236	fabrikantnr.	00-722248
omschrijving	thermokoppelsset ROBERTSHAW 5-delig L 60" - 1525mm ASA 11/32		

thermogeneratoren

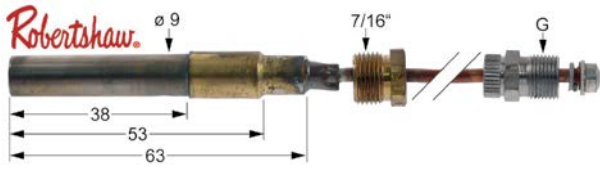

1

bestelnr.	580035	fabrikantnr.	110839-1 410839-1
omschrijving	thermogenerator L 36" - 915mm voeler \varnothing 9mm voeler L 38mm 250-750mV schroefaansluiting 7/16" aansluiting 3/8" NEF		

toebehoren

onderbrekers



1

bestelnr.	580046	fabrikantnr.	00-410838-000G1 110838G1 410838G1
omschrijving	verlenging voor onderbreker L 18" - 455mm		

gasinspuiters

waakvlambranderinspuiters

waakvlambranderinspuiters ROBERTSHAW



1

bestelnr.	100275	fabrikantnr.	109839-6
omschrijving	waakvlaminspuiters flessengas identificatienummer 10 boring \varnothing 0.1mm passend voor ROBERTSHAW		

scharnieren

opliggende scharnieren

diversen



1

bestelnr.	701446	fabrikantnr.	138057-14 430900-1-5
omschrijving	scharnier totale hoogte 54mm met verhoging totale lengte 250mm B 75mm		

korven

friteusekorven

USA-fabrikanten



1

bestelnr.	970183	fabrikantnr.	OY420563-1
omschrijving	friteusekorf L1 308mm B1 160mm H1 135mm		



			
1			
bestelnr.	970184	fabrikantnr.	110782-1 111378-2 410782-1 411378-2 420581-1 4900
omschrijving	friteusekorf L1 330mm B1 315mm H1 135mm		

			
1			
bestelnr.	970182	fabrikantnr.	108654-1 110737-1 110737-7 408654-1 410737-1 410737-7 4712 804712
omschrijving	friteusekorf L1 340mm B1 165mm H1 150mm L2 620mm H2 280mm		

G

gasinspuiters	6
gasregelventielen	3

L

lampen	3
--------	---

M

magneetschakelaars	3
--------------------	---

O

opliggende scharnieren	6
------------------------	---

S

schakelaars en tasters	3
signaallampen	3
signaallampen compleet	3

T

thermokoppels	6
---------------	---

W

waakvlambranders	4
wipschakelaar/drukschakelaars	3